 DE WOLF GOETVINCK HOLVOET JONCKHEERE SPINMOLENPLEIN 192 B-9000 GENT M. +32(0)473.47.29.51 INFO@NET-ARCHITECTUUR.NET	AANBESTEDING - DETAILS	FORMAAT	A4	SCHAAL	1/5
	TYPEDETAIL AANZET SPOUW	DATUM	2024-03-20	GETEKEND	BG
	WIJZIGINGEN	DOSSIER	17.20KKS	TEKENING	VD_001

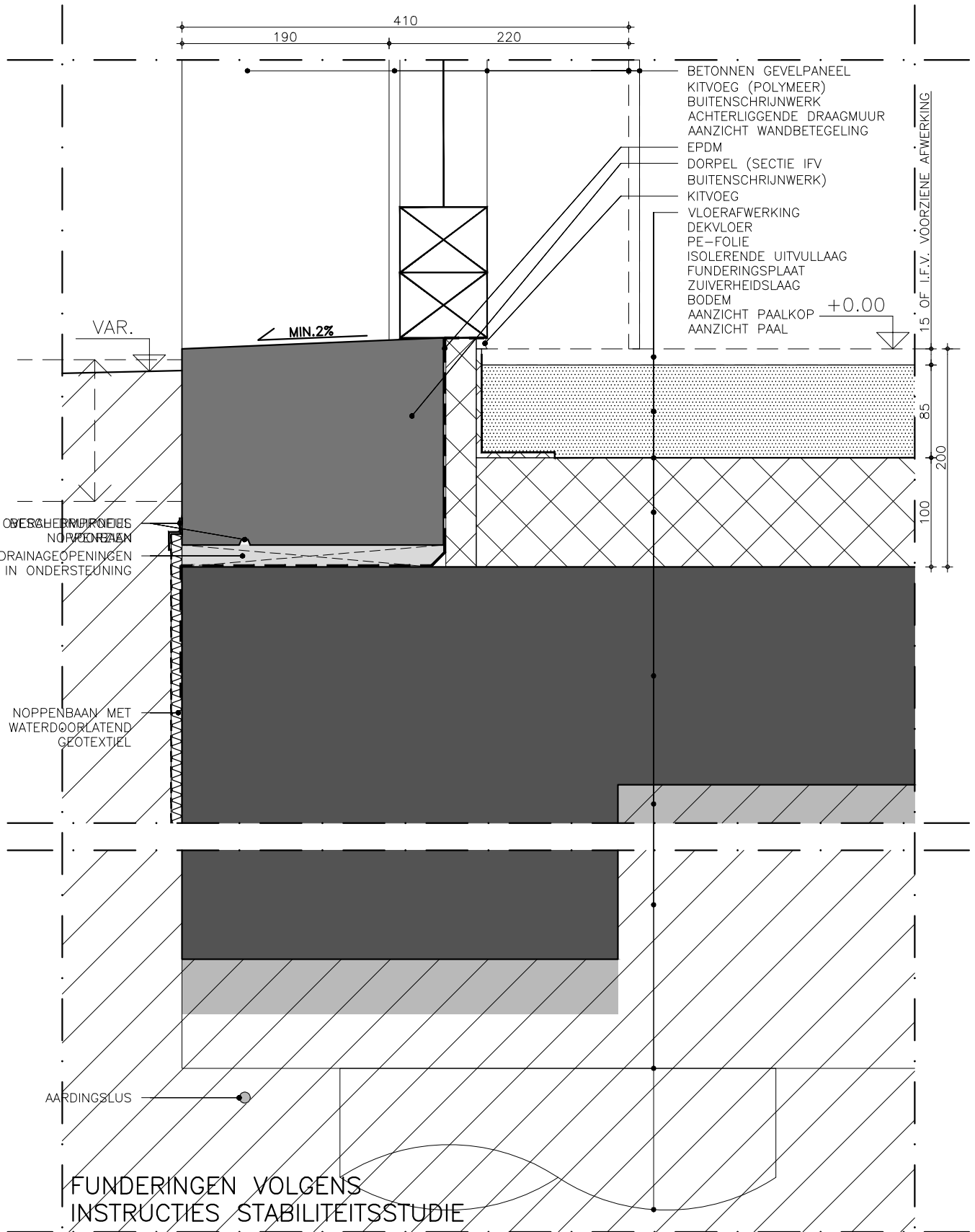

ARCHITECTUUR

DE WOLF GOETVINCK HOLVOET JONCKHEERE
SPINMOLENPLEIN 192
B-9000 GENT
M. +32(0)473.47.29.51
INFO@NET-ARCHITECTUUR.NET

AANBESTEDING - DETAILS

TYPEDETAIL AANSLUITING RAAM N+0

WIJZIGINGEN

-
-
-

FORMAAT

A4

DATUM

2024-03-20

DOSSIER

17.20KKS

SCHAAL

1/5

GETEKEND

BG

TEKENING

VD_002

TUINMUREN / TUINPOORT

ZIE OOK DETAIL A_03

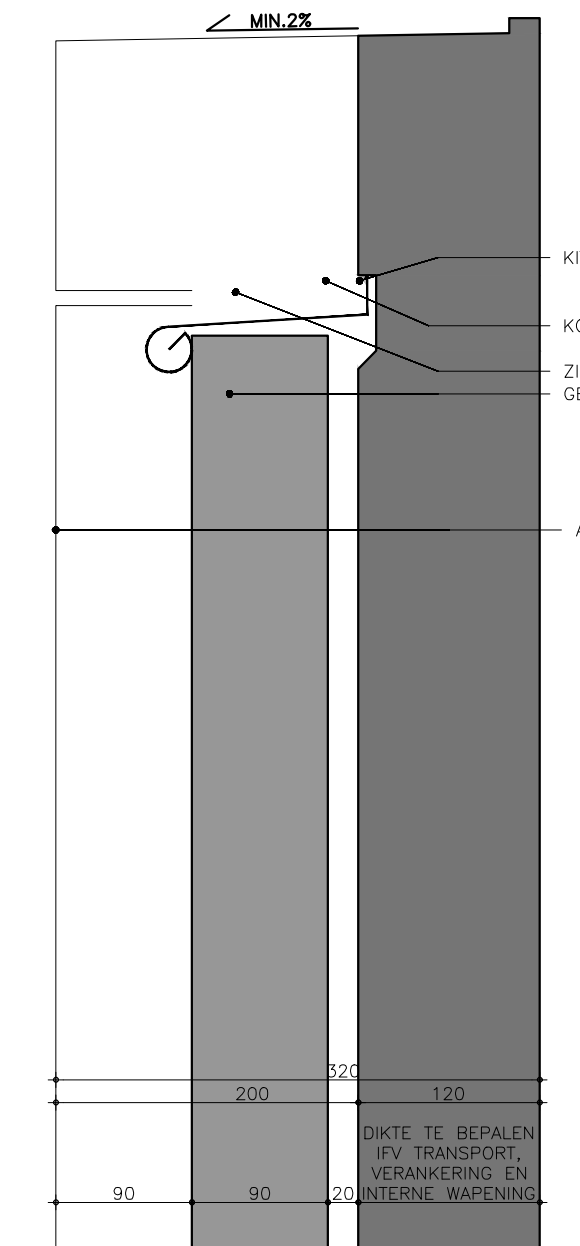

SNEDE 1

KITVOEG
 KOPSE ZIJDE ANALOOG
 OP TE LOSSEN
 ZINKEN KRAAL
 GEVELSTEEN PAREMENT
 BETONNEN GEVELPANEEL
 TER PLAATSE GESTORT
 BETON (IN HET ZICHT
 BLIJVEND – GLAD TE
 BEKISTEN)
 AANZICHT TER PLAATSE
 GESTORT BETON

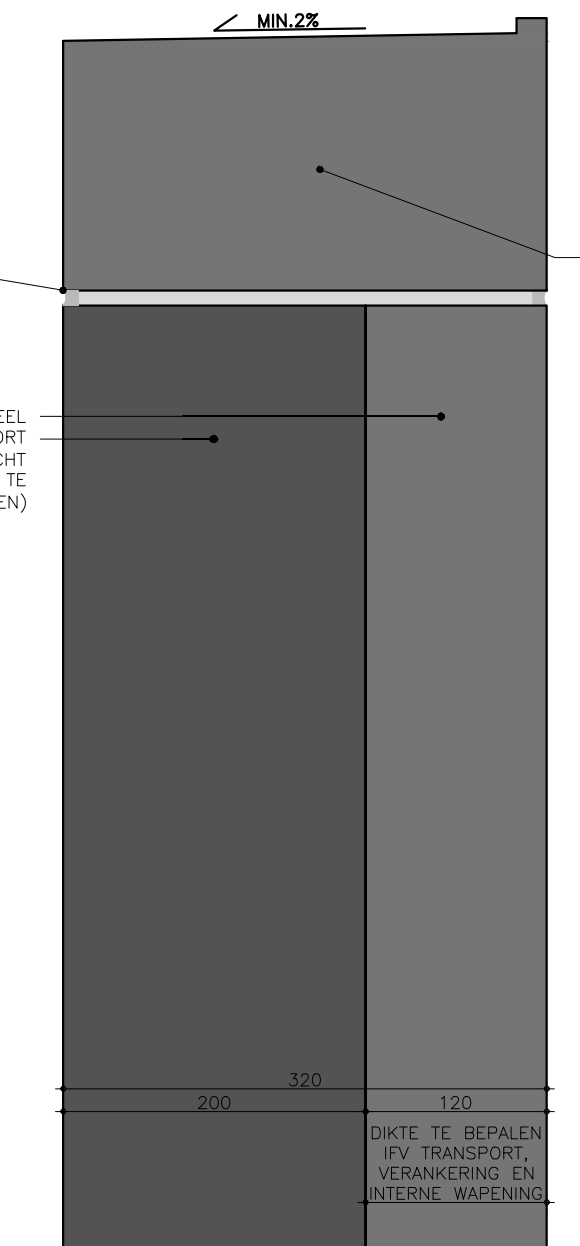

SNEDE 2

DEKSTEEN ZICHTBETON
 (INBEGREPEN BIJ
 PANEEL)
 TUINPOORT IN STAAL (MET
 SCHUINE LAMELLEN /
 SPIJLEN)
 AANZICHT TER PLAATSE
 GESTORT BETON
 AANSLUITING TER PLAATSE
 GESTORT BETON MET
 PREFAB BETON NETJES
 UIT TE VOEREN !

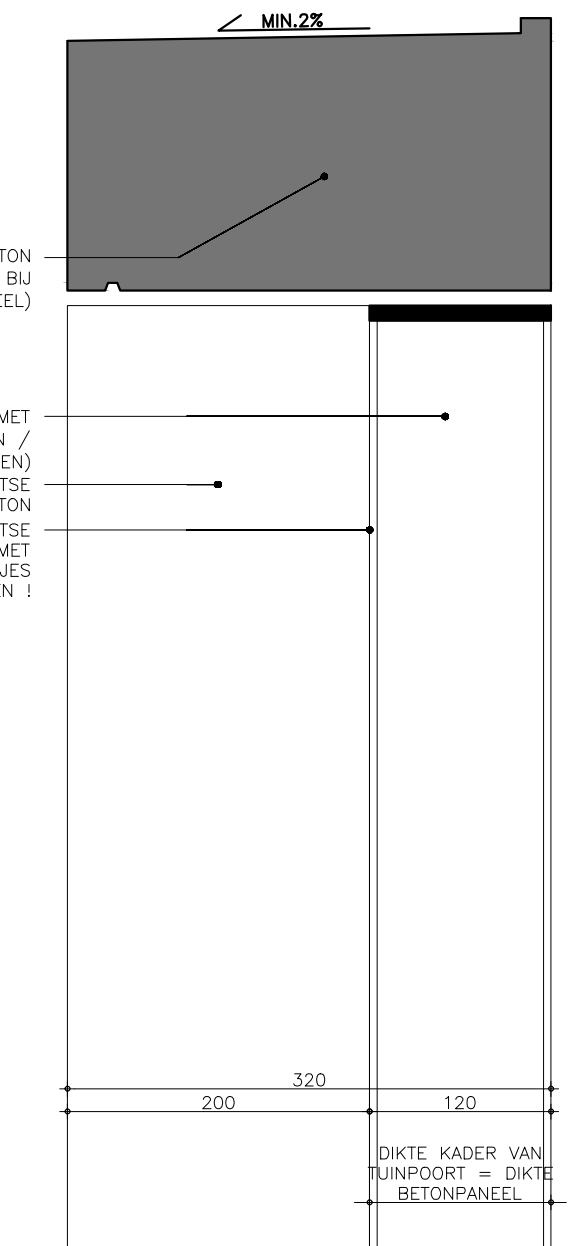

SNEDE 3

DIKTE KADER VAN
 TUINPOORT = DIKTE
 BETONPANEEL

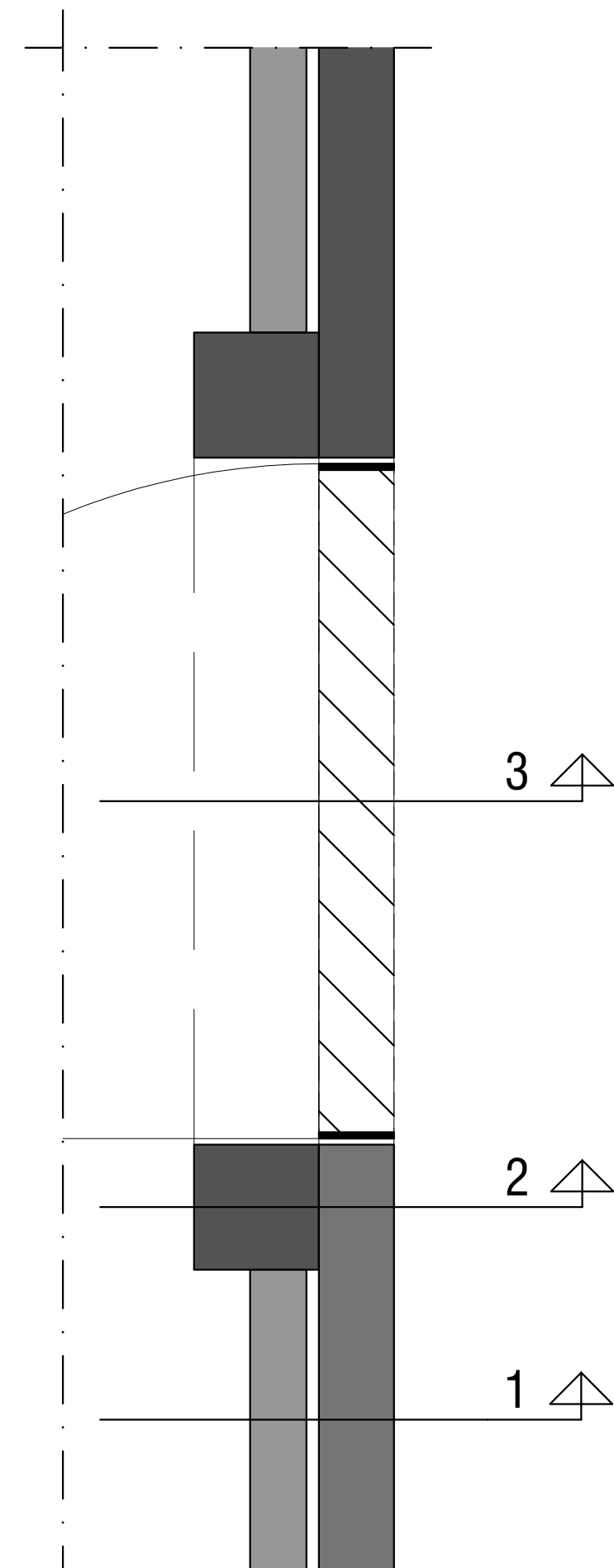

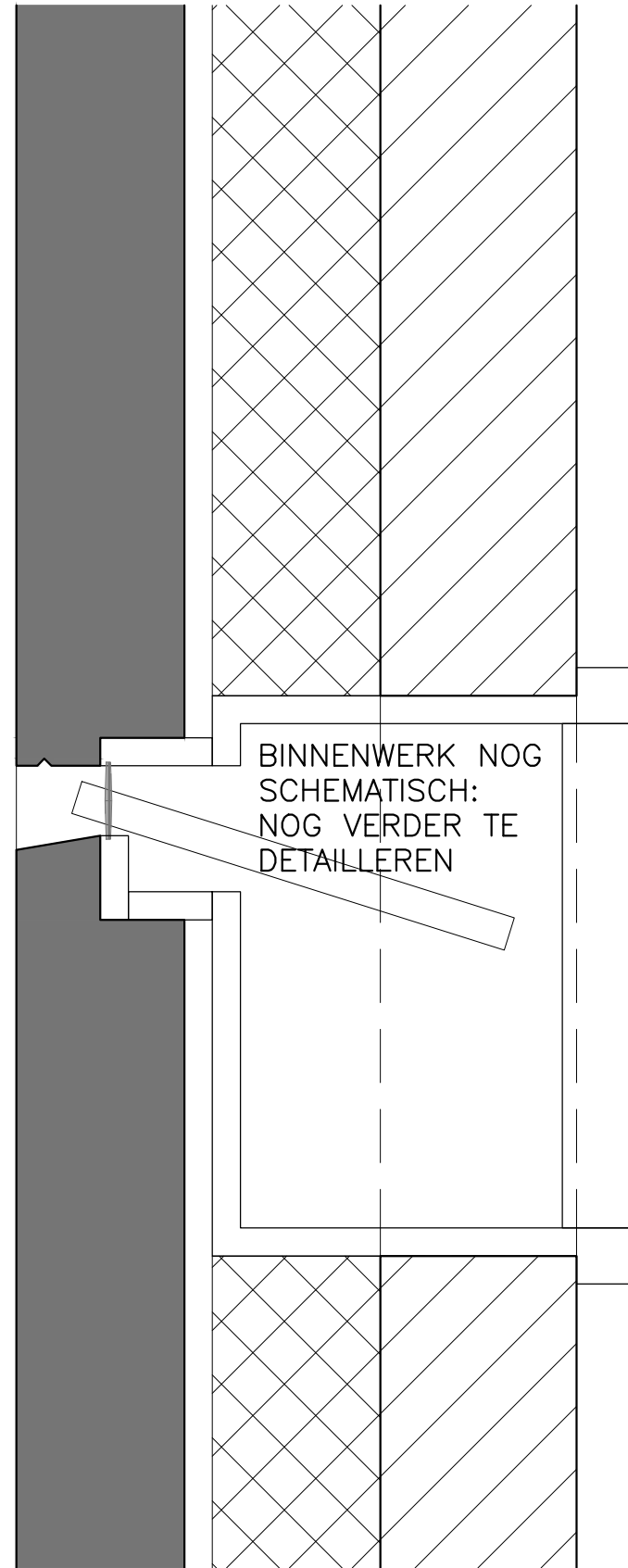
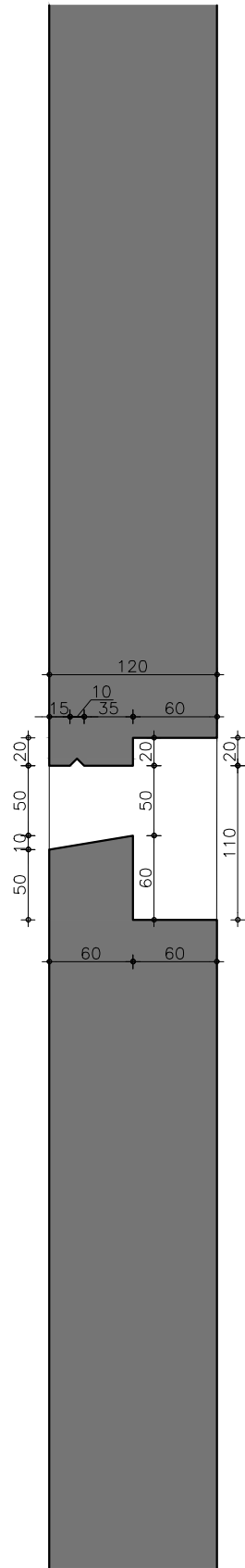

PLANSNEDE 1/10

ARCHITECTUUR DE WOLF GOETVINCK HOLVOET JONCKHEERE SPINMOLENPLEIN 192 B-9000 GENT M. +32(0)473.47.29.51 INFO@NET-ARCHITECTUUR.NET	AANBESTEDING - DETAILS	FORMAAT A4	SCHAAL 1/5
	PRINCIPEDETAIL TUINMUUR	DATUM 2024-03-20	GETEKEND BG
	WIJZIGINGEN	DOSSIER 17.20KKS	TEKENING VD_003
	- - -		

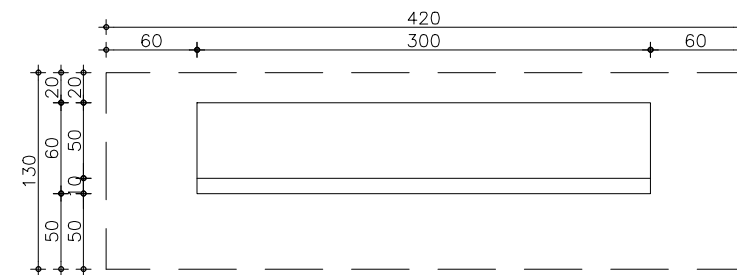
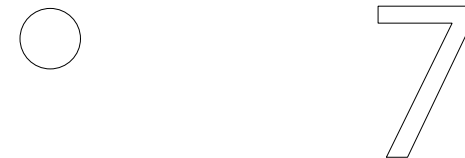

BEL NOG ON HOLD



 ARCHITECTUUR DE WOLF GOETVINCK HOLVOET JONCKHEERE SPINMOLENPLEIN 192 B-9000 GENT M. +32(0)473.47.29.51 INFO@NET-ARCHITECTUUR.NET	AANBESTEDING - DETAILS	FORMAAT A4	SCHAAL 1/5
	VOORSTEL UITSPARING BRIEFBUSSEN	DATUM 2024-03-20	GETEKEND BG
	WIJZIGINGEN	DOSSIER	TEKENING
	-	17.20KKS	VD_004

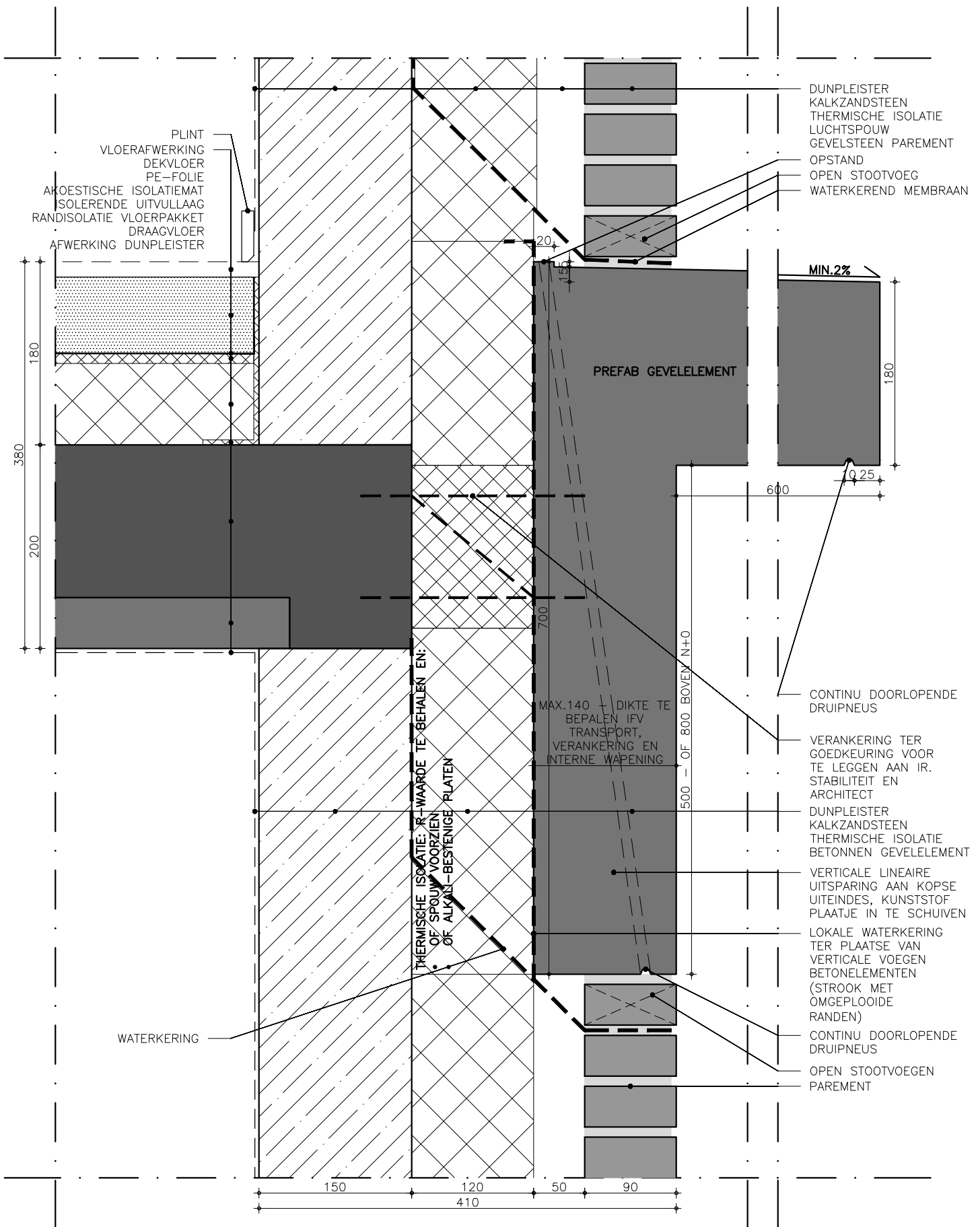

 ARCHITECTUUR DE WOLF GOETVINCK HOLVOET JONCKHEERE SPINMOLENPLEIN 192 B-9000 GENT M. +32(0)473.47.29.51 INFO@NET-ARCHITECTUUR.NET	AANBESTEDING - DETAILS	FORMAAT	A4	SCHAAL	1/5
	GEVELBETON - 60CM UITKR. - AANSL. MUUR	DATUM	2024-03-20	GETEKEND	BG
	WIJZIGINGEN	DOSSIER	17.20KKS	TEKENING	VD_101

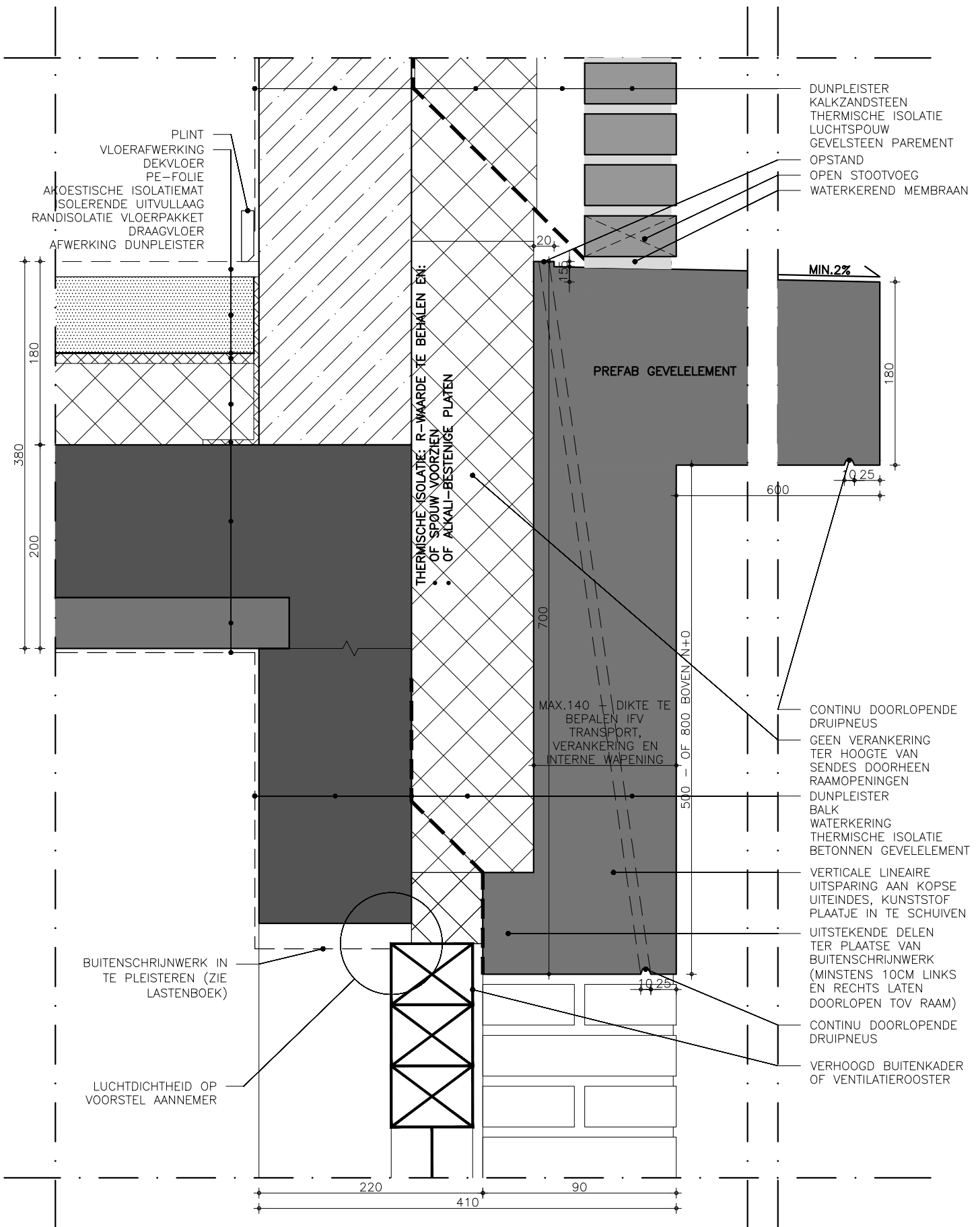

 <p>DE WOLF GOETVINCK HOLVOET JONCKHEERE SPINMOLENPLEIN 192 B-9000 GENT M. +32(0)473.47.29.51 INFO@NET-ARCHITECTUUR.NET</p>	AANBESTEDING - DETAILS	FORMAAT	A4	SCHAAL	1/5
	GEVELBETON - 60CM UITKR. - AANSL. RAAM 1	DATUM	2024-03-20	GETEKEND	BG
	WIJZIGINGEN	DOSSIER	17.20KKS	TEKENING	VD_102

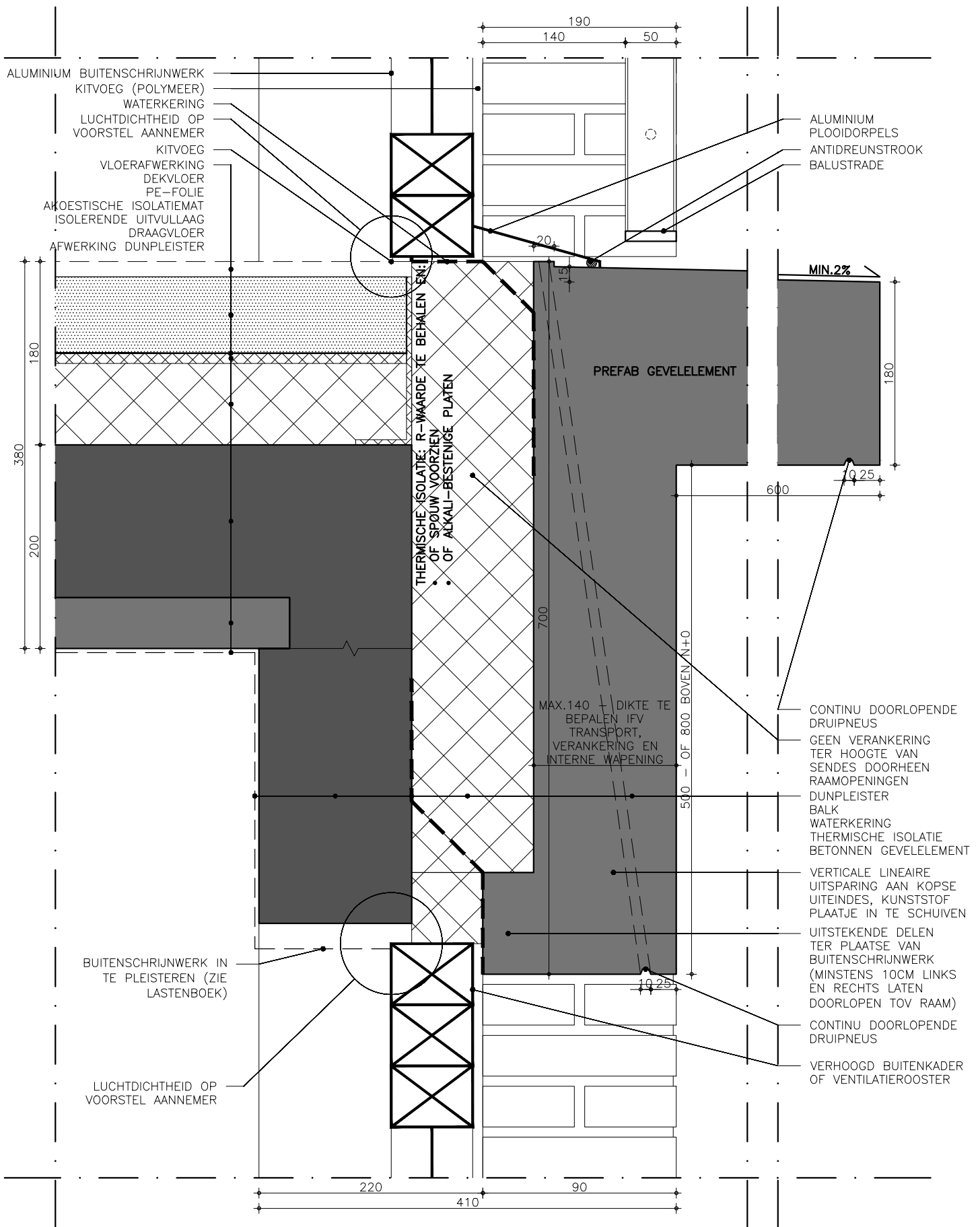

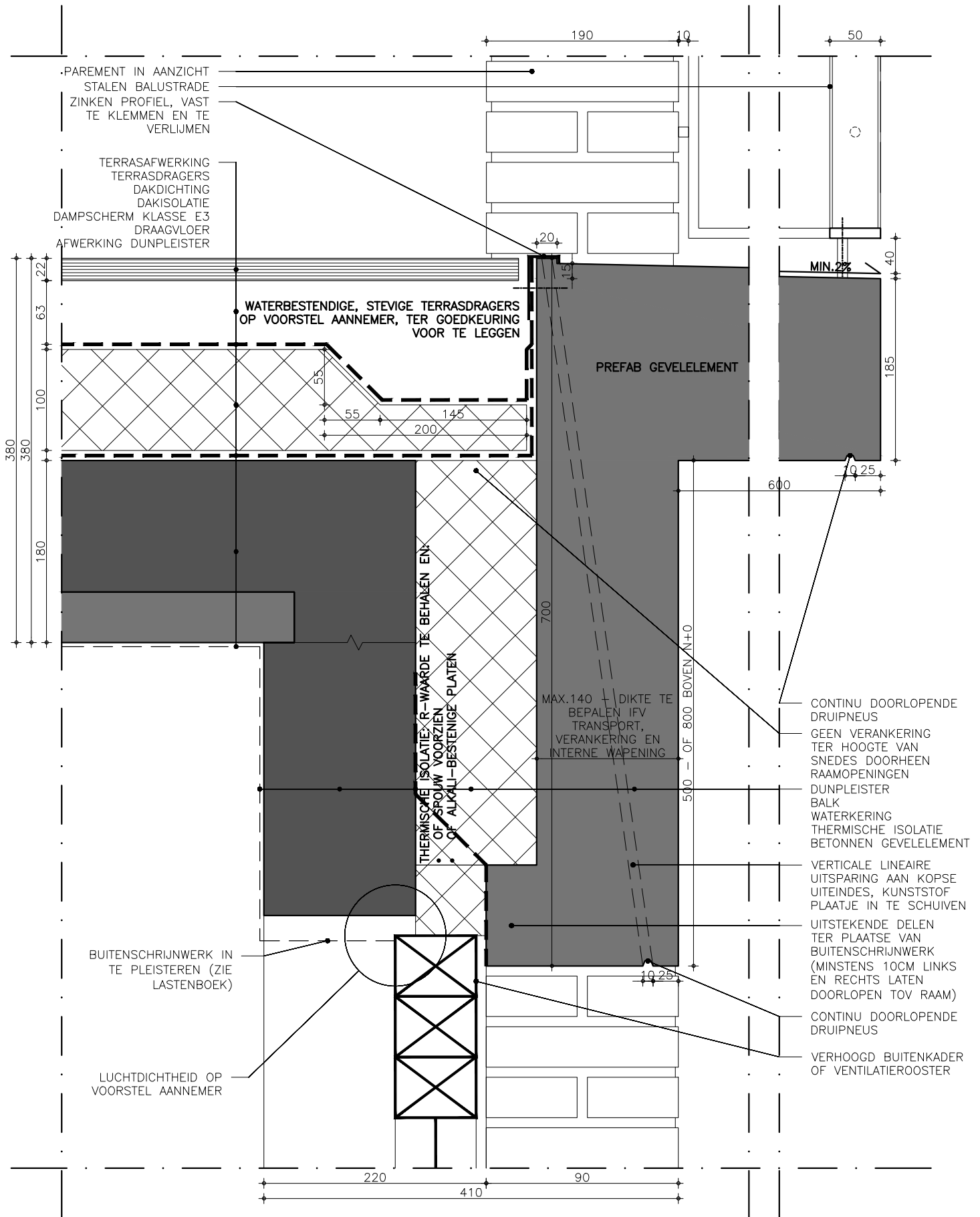

 ARCHITECTUUR DE WOLF GOETVINCK HOLVOET JONCKHEERE SPINMOLENPLEIN 192 B-9000 GENT M. +32(0)473.47.29.51 INFO@NET-ARCHITECTUUR.NET	AANBESTEDING - DETAILS	FORMAAT	A4	SCHAAL	1/5
	GEVELBETON - 60CM UITKR. - AANSL. RAAM 2	DATUM	2024-03-20	GETEKEND	BG
	WIJZIGINGEN	DOSSIER	17.20KKS		TEKENING VD_103



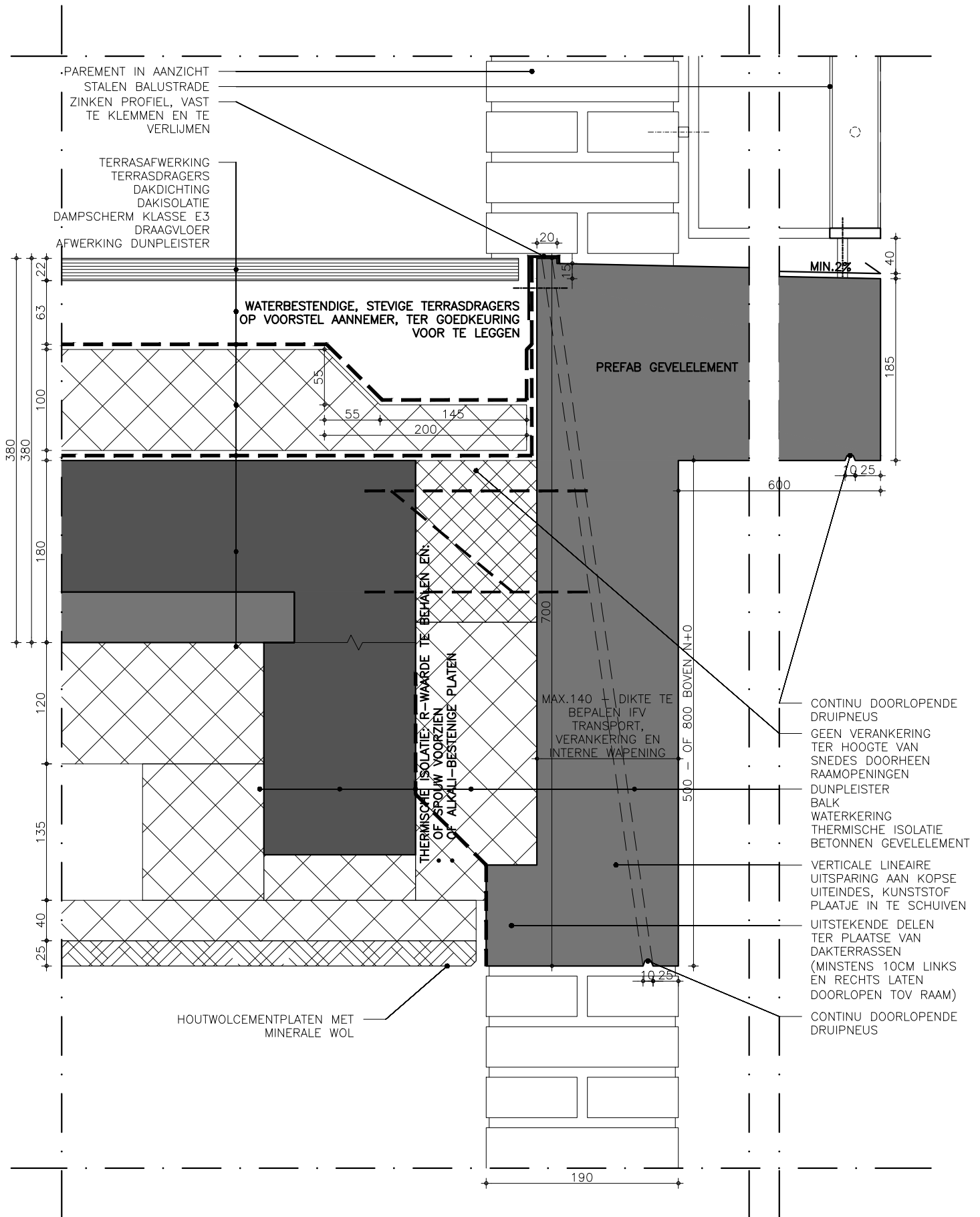

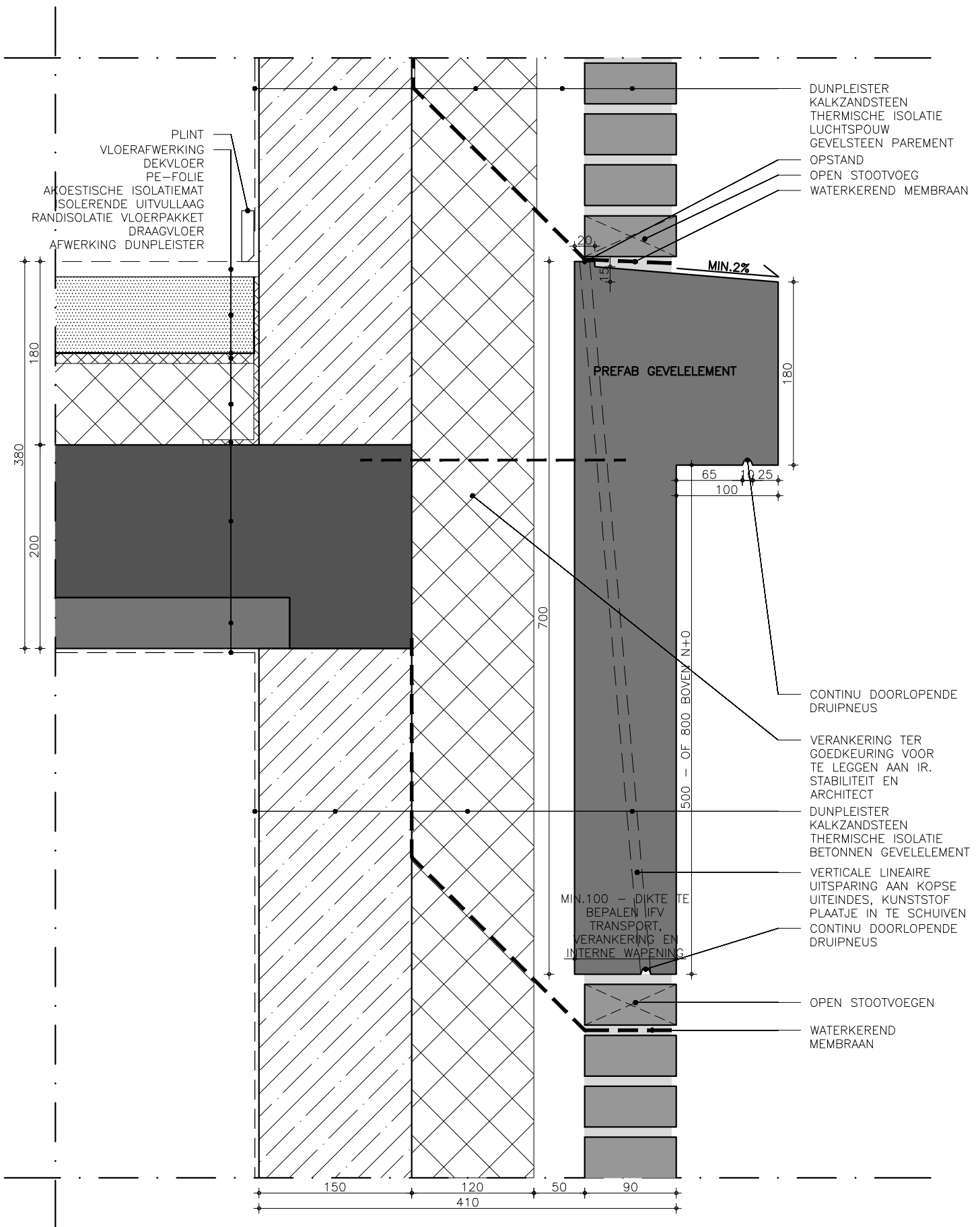
 ARCHITECTUUR DE WOLF GOETVINCK HOLVOET JONCKHEERE SPINMOLENPLEIN 192 B-9000 GENT M. +32(0)473.47.29.51 INFO@NET-ARCHITECTUUR.NET	AANBESTEDING - DETAILS	FORMAAT	A4	SCHAAL	1/5	
	GEVELBETON - 10CM UITKR. - AANSL. TERRAS 1	DATUM	2024-03-20		GETEKEND	BG
	WIJZIGINGEN	DOSSIER	17.20KKS		TEKENING	VD_104





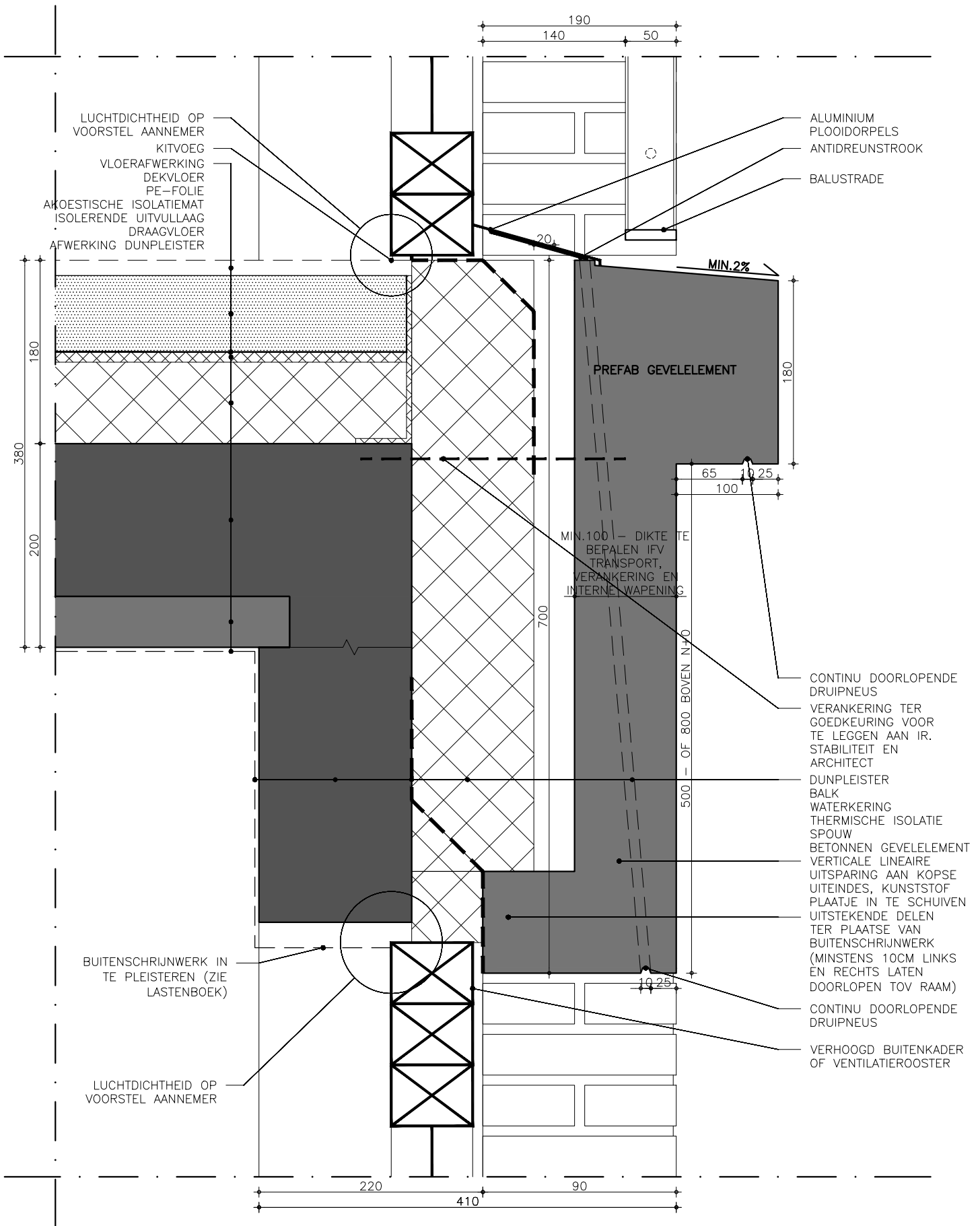

 DE WOLF GOETVINCK HOLVOET JONCKHEERE SPINMOLENPLEIN 192 B-9000 GENT M. +32(0)473.47.29.51 INFO@NET-ARCHITECTUUR.NET	AANBESTEDING - DETAILS	FORMAAT	A4	SCHAAL	1/5
	GEVELBETON - 10CM UITKR. - AANSL. MUUR	DATUM	2024-03-20	GETEKEND	BG
	WIJZIGINGEN	DOSSIER	17.20KKS	TEKENING	VD_106



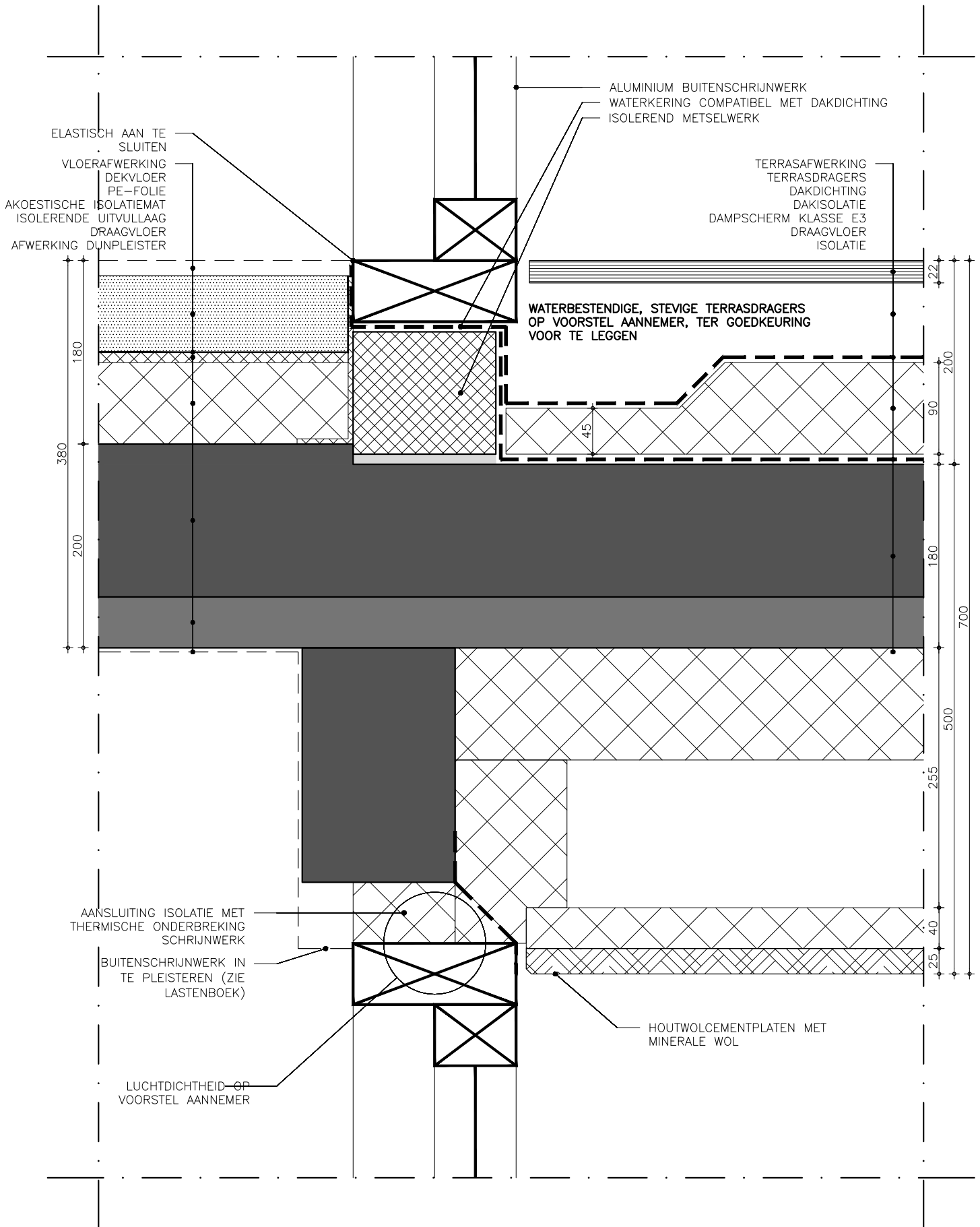

 DE WOLF GOETVINCK HOLVOET JONCKHEERE SPINMOLENPLEIN 192 B-9000 GENT M. +32(0)473.47.29.51 INFO@NET-ARCHITECTUUR.NET	AANBESTEDING - DETAILS	FORMAAT	A4	SCHAAL	1/5
	GEVELBETON - 10CM UITKR. - AANSL. RAAM	DATUM	2024-03-20	GETEKEND	BG
	WIJZIGINGEN	DOSSIER	17.20KKS	TEKENING	VD_107



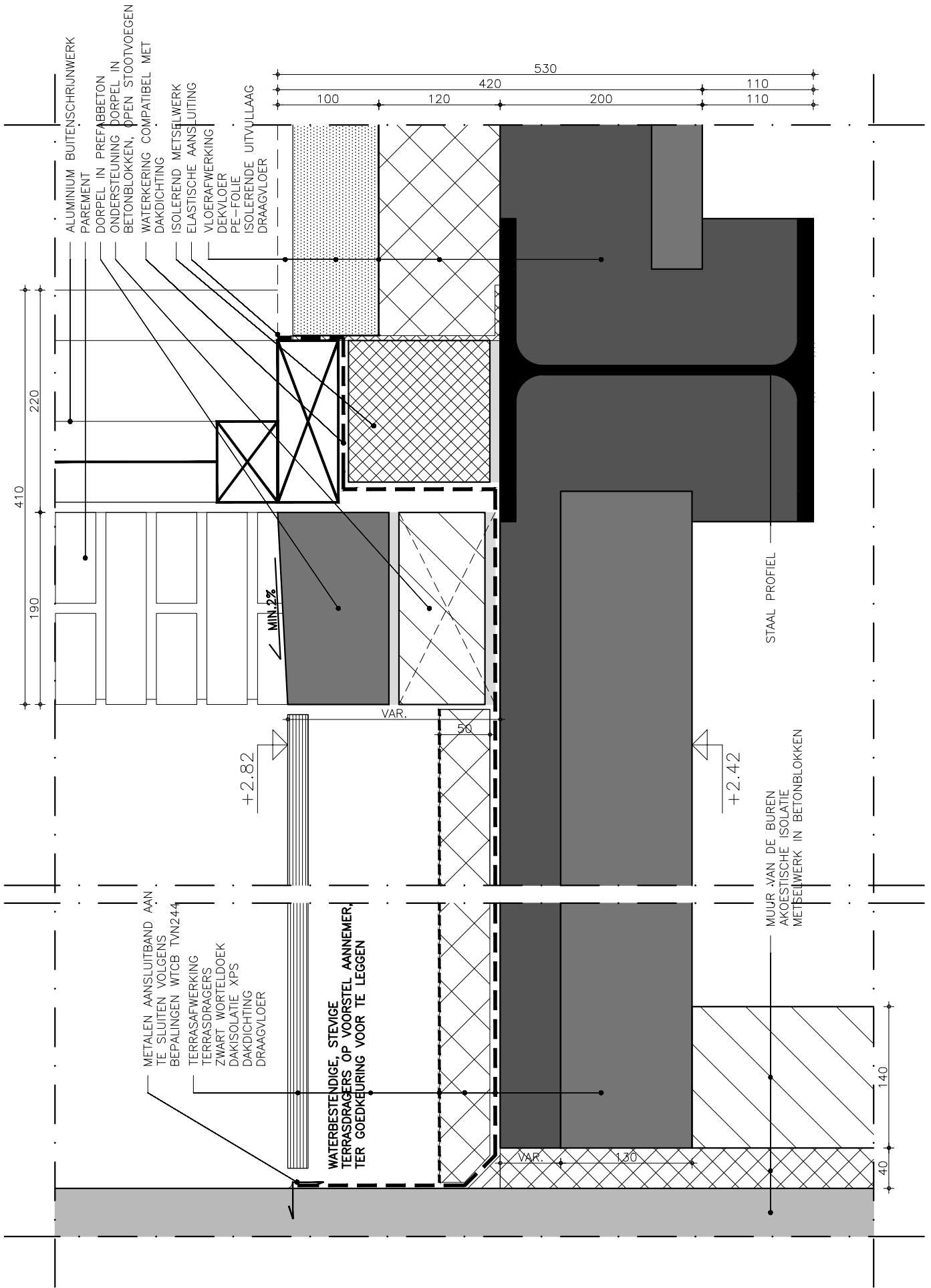

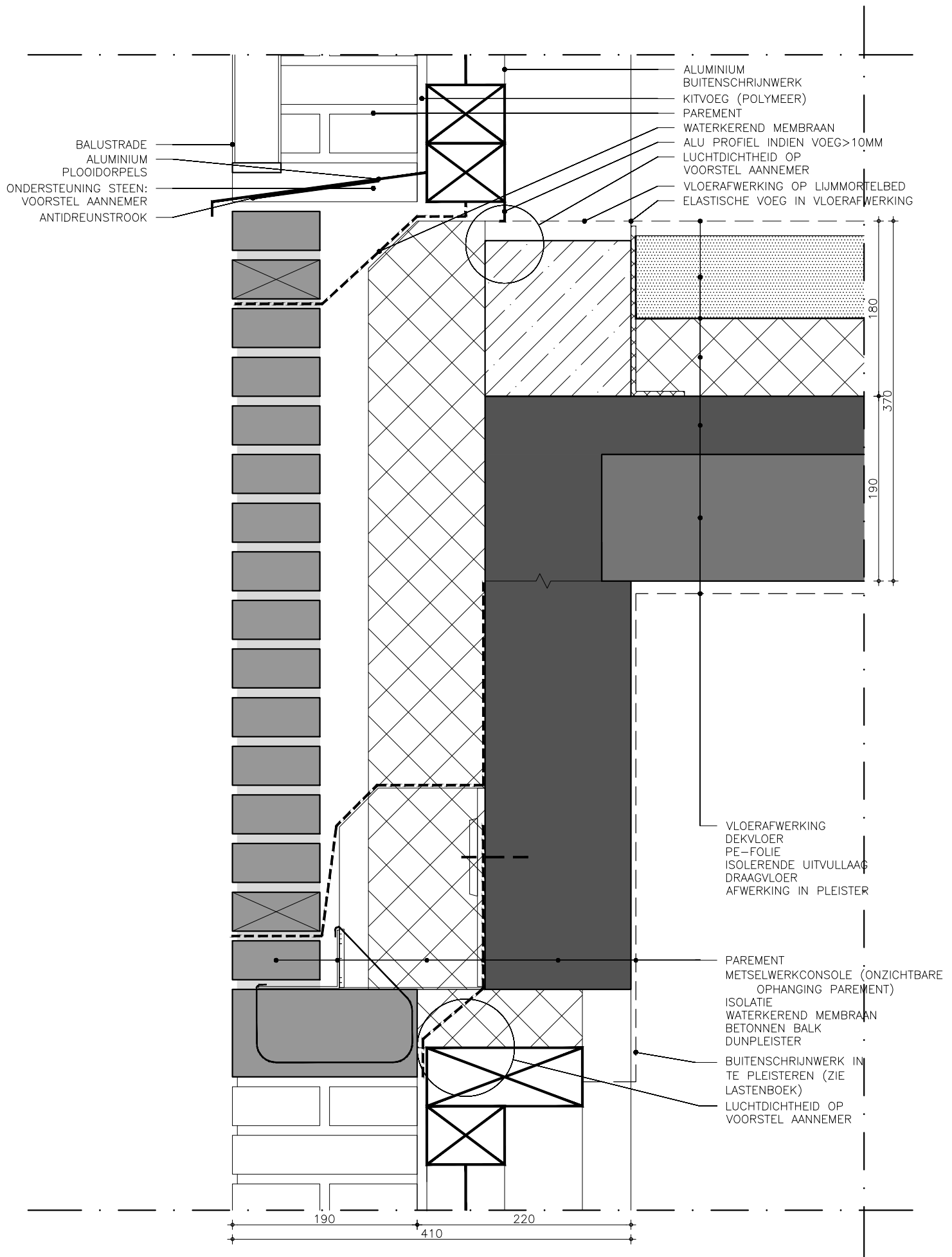
 DE WOLF GOETVINCK HOLVOET JONCKHEERE SPINMOLENPLEIN 192 B-9000 GENT M. +32(0)473.47.29.51 INFO@NET-ARCHITECTUUR.NET	AANBESTEDING - DETAILS	FORMAAT	A4	SCHAAL	1/5
	AANSLUITING INPANDIG TERRAS	DATUM	2024-03-20	GETEKEND	BG
	WIJZIGINGEN	DOSSIER	17.20KKS	TEKENING	VD_108





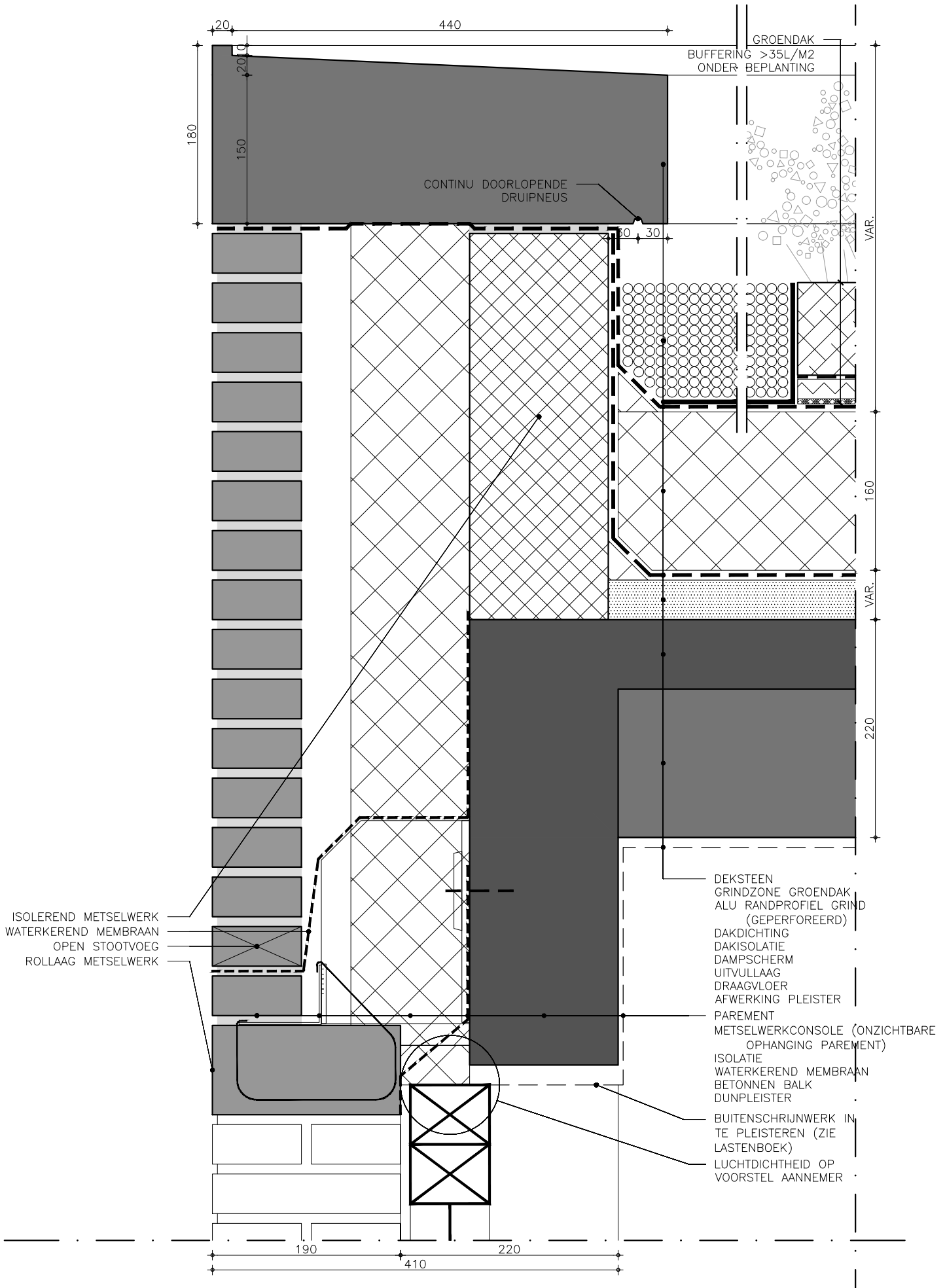

 DE WOLF GOETVINCK HOLVOET JONCKHEERE SPINMOLENPLEIN 192 B-9000 GENT M. +32(0)473.47.29.51 INFO@NET-ARCHITECTUUR.NET	AANBESTEDING - DETAILS	FORMAAT	A4	SCHAAL	1/5
	PRINCIPEDETAIL RAAM BLOK B	DATUM	2024-03-20	GETEKEND	BG
	WIJZIGINGEN	DOSSIER	17.20KKS	TEKENING	VD_200

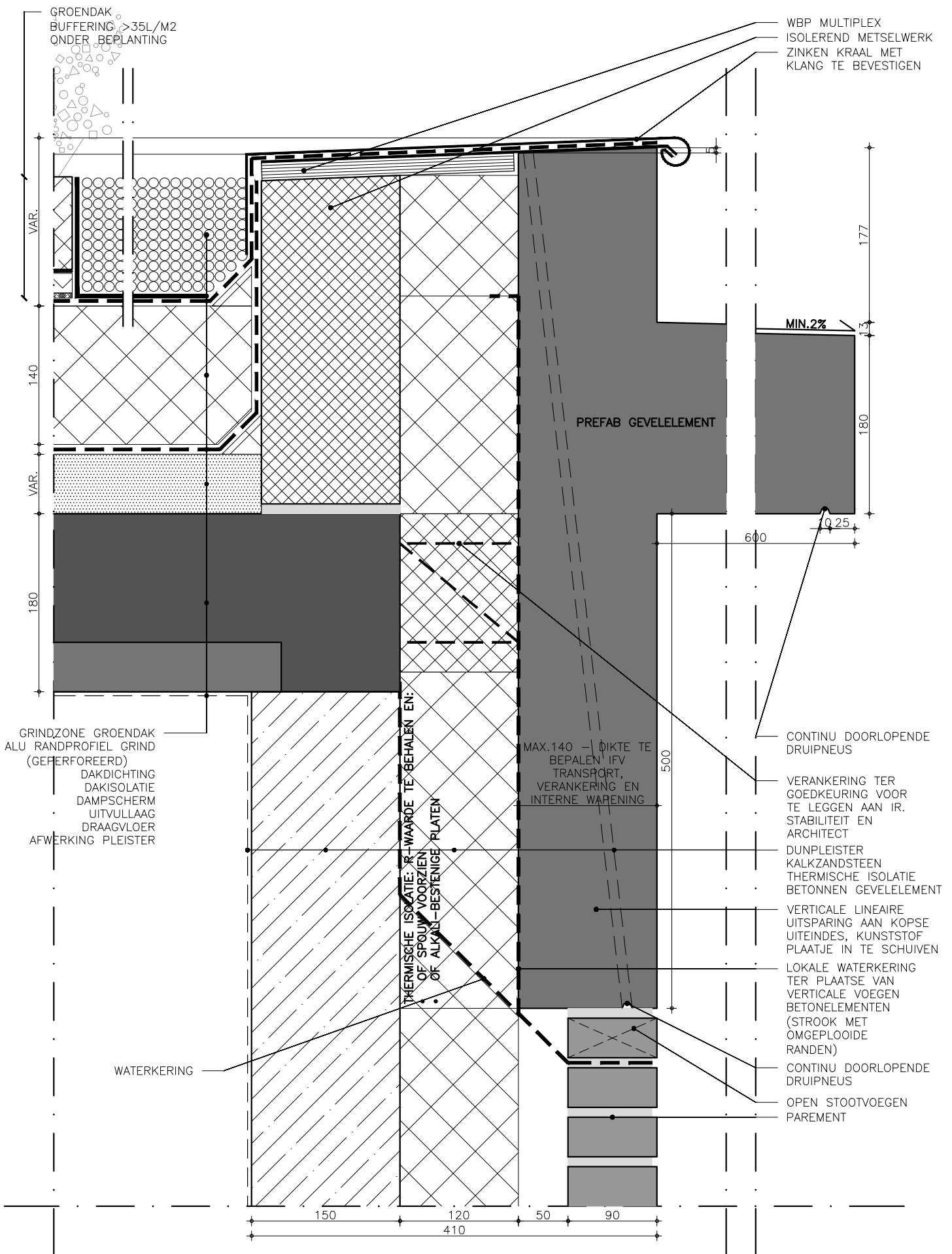

 ARCHITECTUUR DE WOLF GOETVINCK HOLVOET JONCKHEERE SPINMOLENPLEIN 192 B-9000 GENT M. +32(0)473.47.29.51 INFO@NET-ARCHITECTUUR.NET	AANBESTEDING - DETAILS	FORMAAT	A4	SCHAAL	1/5
	PRINCIPEDETAIL DAKOPSTAND BLOK B	DATUM	2024-03-20	GETEKEND	BG
	WIJZIGINGEN	DOSSIER	17.20KKS	TEKENING	VD_300



 ARCHITECTUUR DE WOLF GOETVINCK HOLVOET JONCKHEERE SPINMOLENPLEIN 192 B-9000 GENT M. +32(0)473.47.29.51 INFO@NET-ARCHITECTUUR.NET	AANBESTEDING - DETAILS	FORMAAT	A4	SCHAAL	1/5
	DAKOPSTAND HOOFDDAK BLOK A	DATUM	2024-03-20	GETEKEND	BG
	WIJZIGINGEN	DOSSIER	17.20KKS		TEKENING

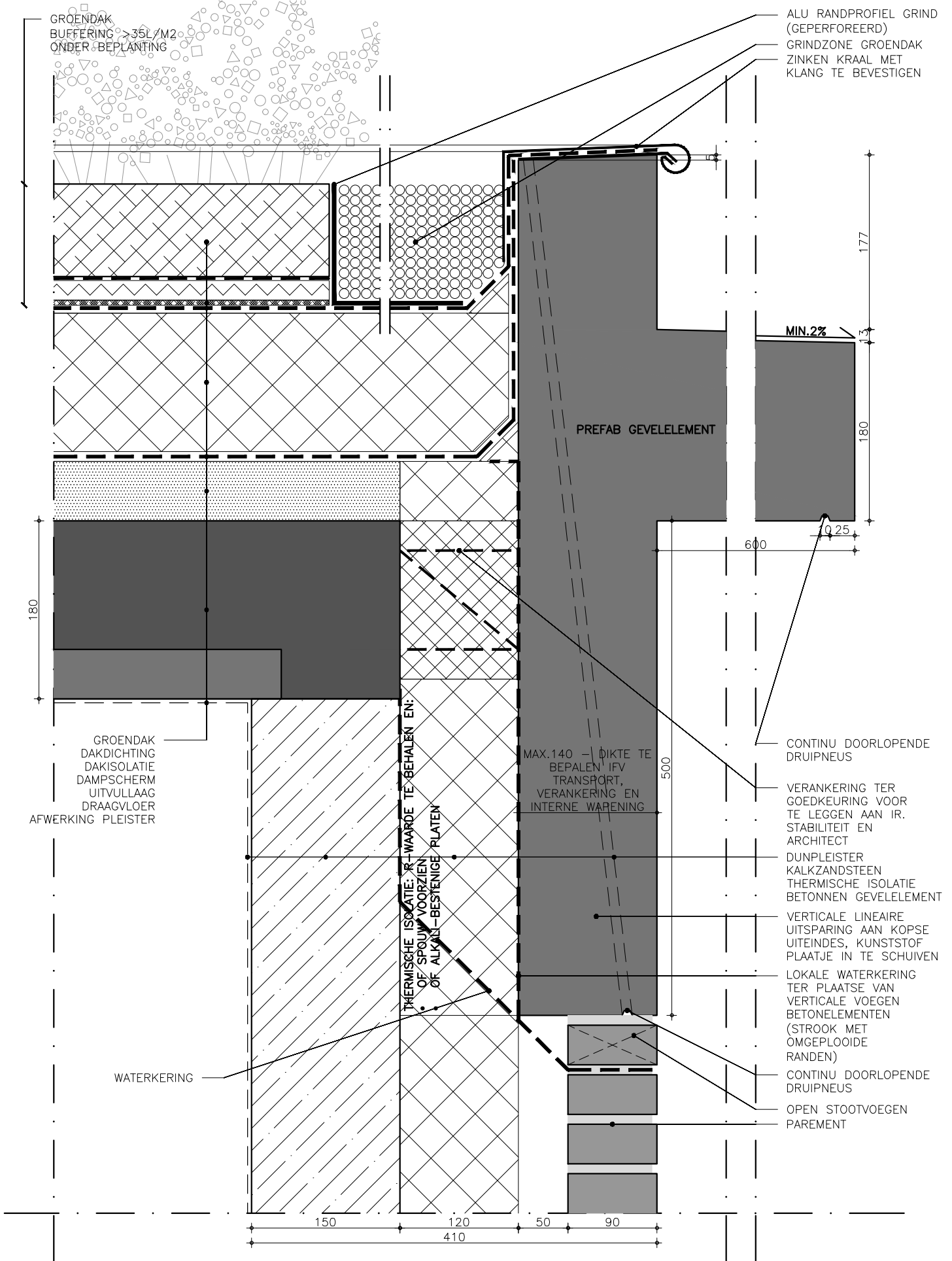

 DE WOLF GOETVINCK HOLVOET JONCKHEERE SPINMOLENPLEIN 192 B-9000 GENT M. +32(0)473.47.29.51 INFO@NET-ARCHITECTUUR.NET	AANBESTEDING - DETAILS	FORMAAT	A4	SCHAAL	1/5
	DAKOPSTAND DAKTERRAS BLOK C	DATUM	2024-03-20	GETEKEND	BG
	WIJZIGINGEN	DOSSIER	17.20KKS	TEKENING	VD_401

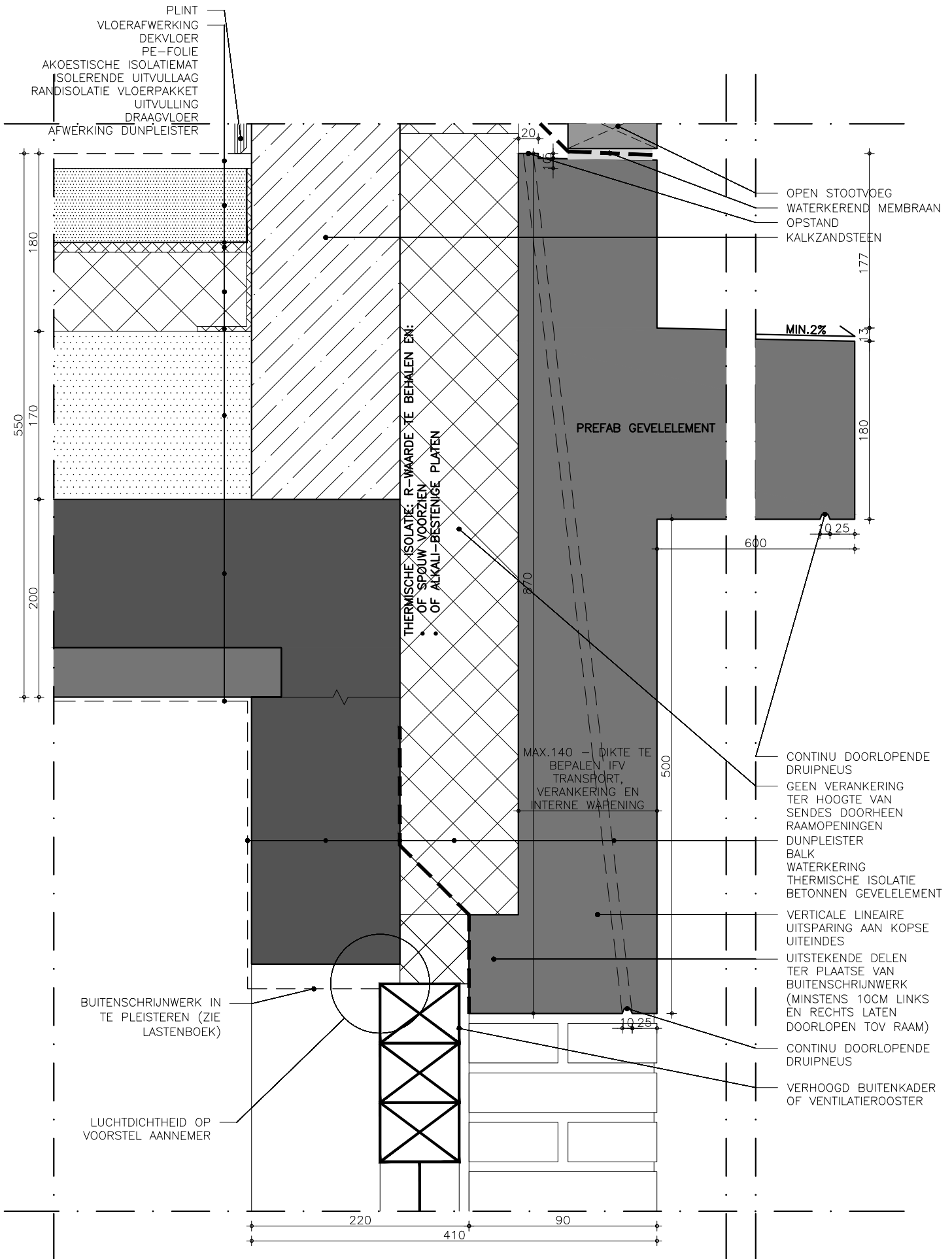

 ARCHITECTUUR DE WOLF GOETVINCK HOLVOET JONCKHEERE SPINMOLENPLEIN 192 B-9000 GENT M. +32(0)473.47.29.51 INFO@NET-ARCHITECTUUR.NET	AANBESTEDING - DETAILS	FORMAAT	A4	SCHAAL	1/5
	GEVELEMENT BLOK C N+4	DATUM	2024-03-20	GETEKEND	BG
	WIJZIGINGEN	DOSSIER	17.20KKS	TEKENING	VD_402

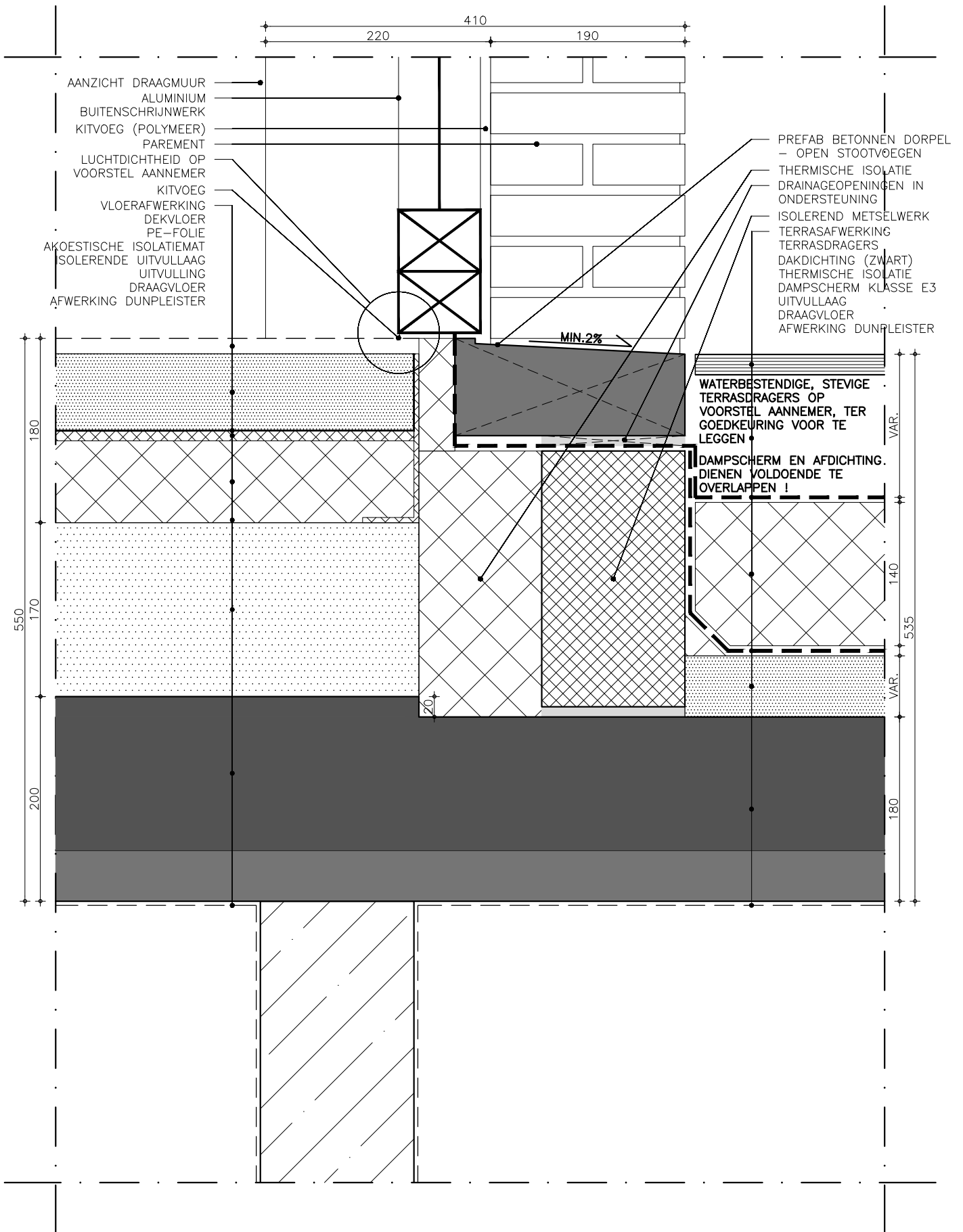

 DE WOLF GOETVINCK HOLVOET JONCKHEERE SPINMOLENPLEIN 192 B-9000 GENT M. +32(0)473.47.29.51 INFO@NET-ARCHITECTUUR.NET	AANBESTEDING - DETAILS	FORMAAT A4	SCHAAL 1/5
	AANSLUITING DAKTERRAS BLOK C	DATUM 2024-03-20	GETEKEND BG
	WIJZIGINGEN - -	DOSSIER 17.20KKS	TEKENING VD_403

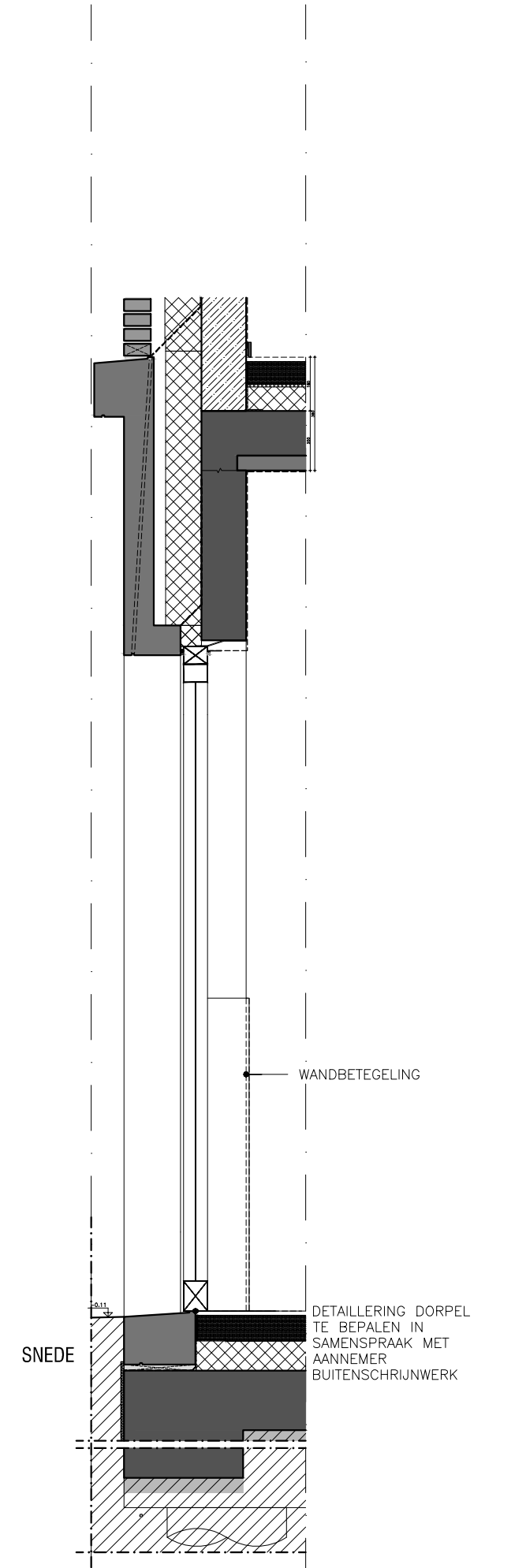
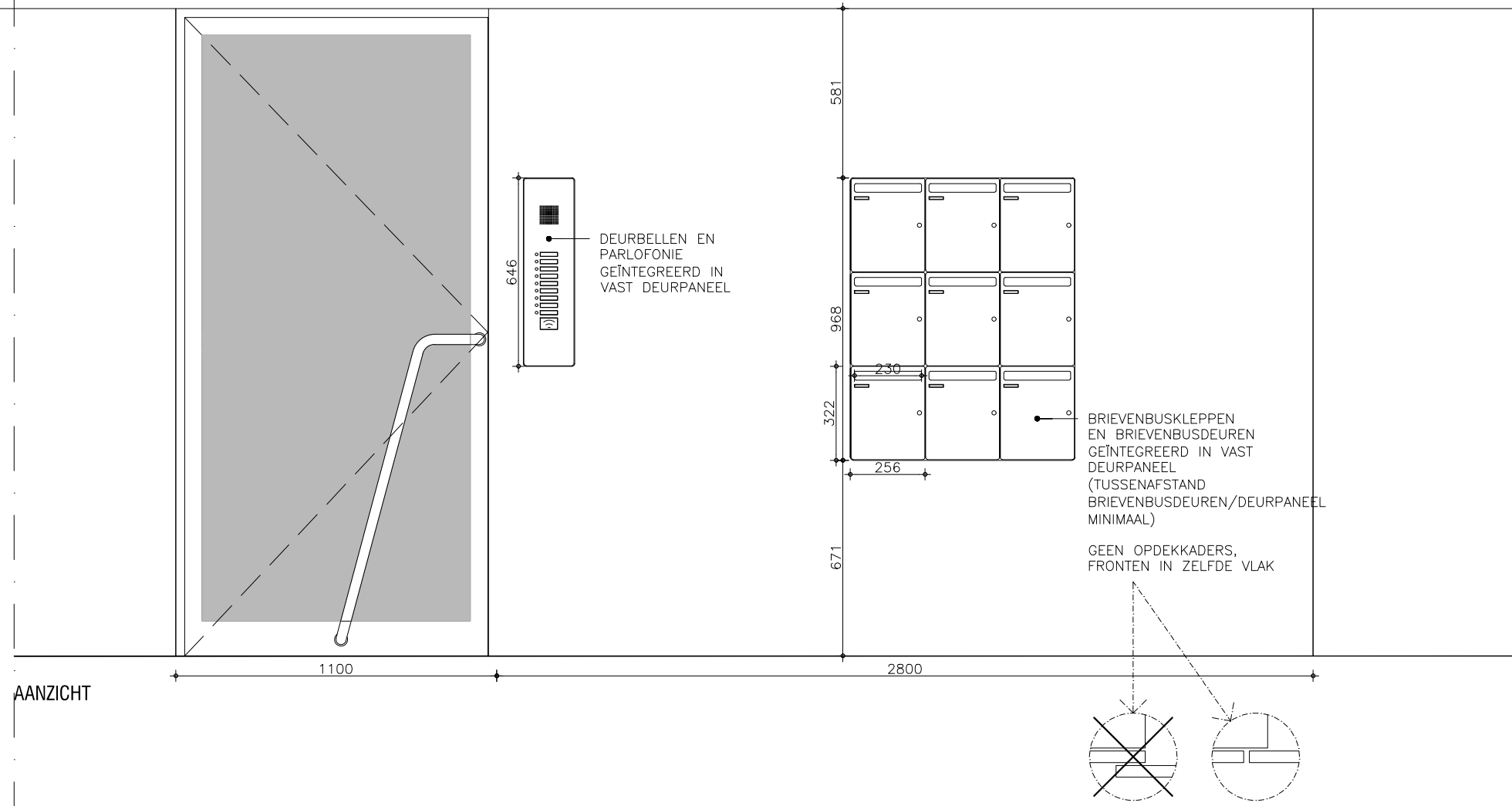
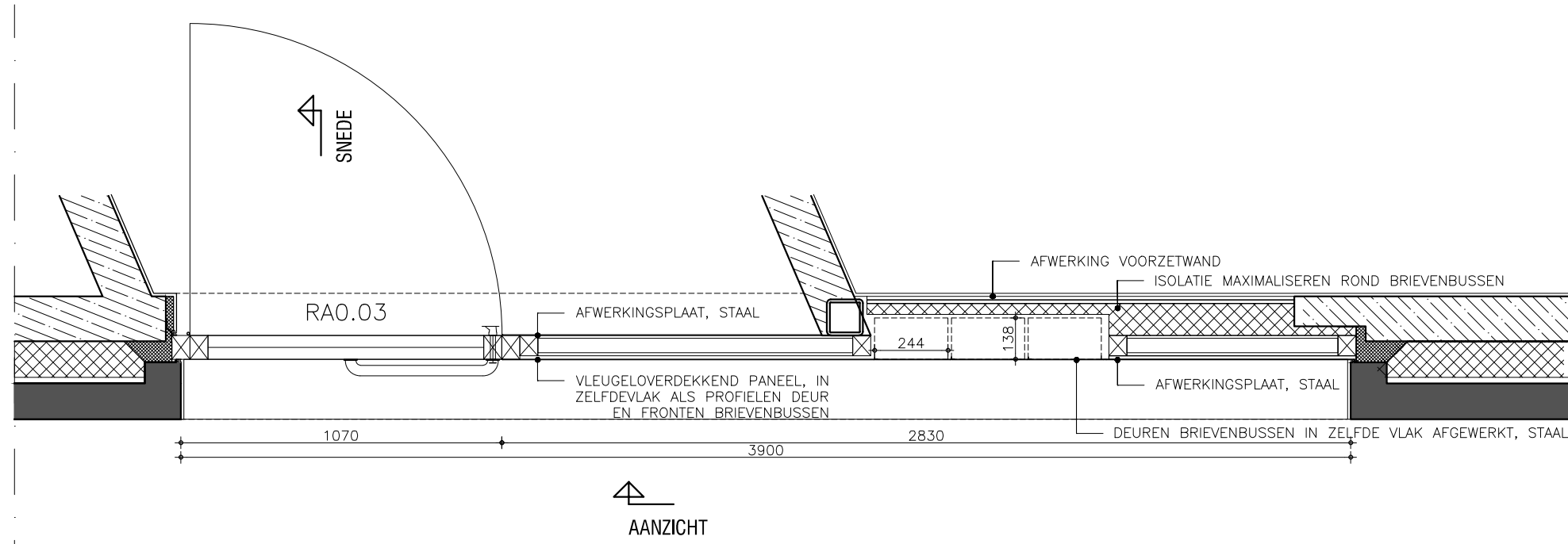

ARCHITECTUUR DE WOLF GOETVINCK HOLVOET JONCKHEERE SPINMOLENPLEIN 192 B-9000 GENT M. +32(0)473.47.29.51 INFO@NET-ARCHITECTUUR.NET	AANBESTEDING - DETAILS	FORMAAT A3	SCHAAL 1/20
	BUITENSCHRIJNWERK INKOMDEUR BLOK A	DATUM 2024-03-20	GETEKEND AV
	WIJZIGINGEN	DOSSIER	TEKENING
	-	17.20KKS	A_001

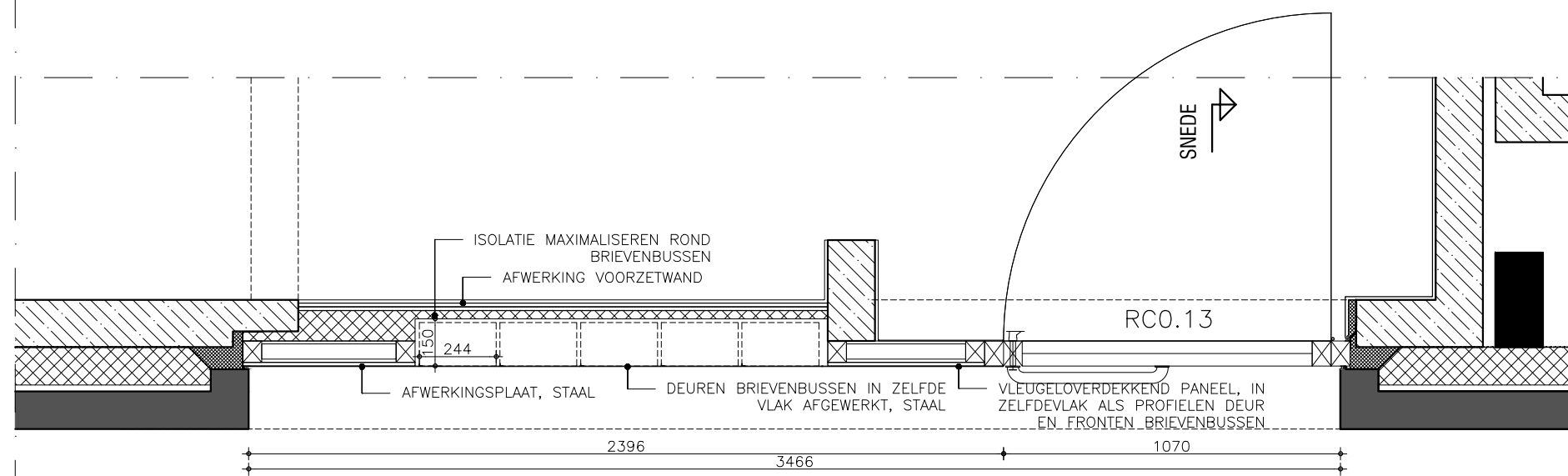

AANZICHT

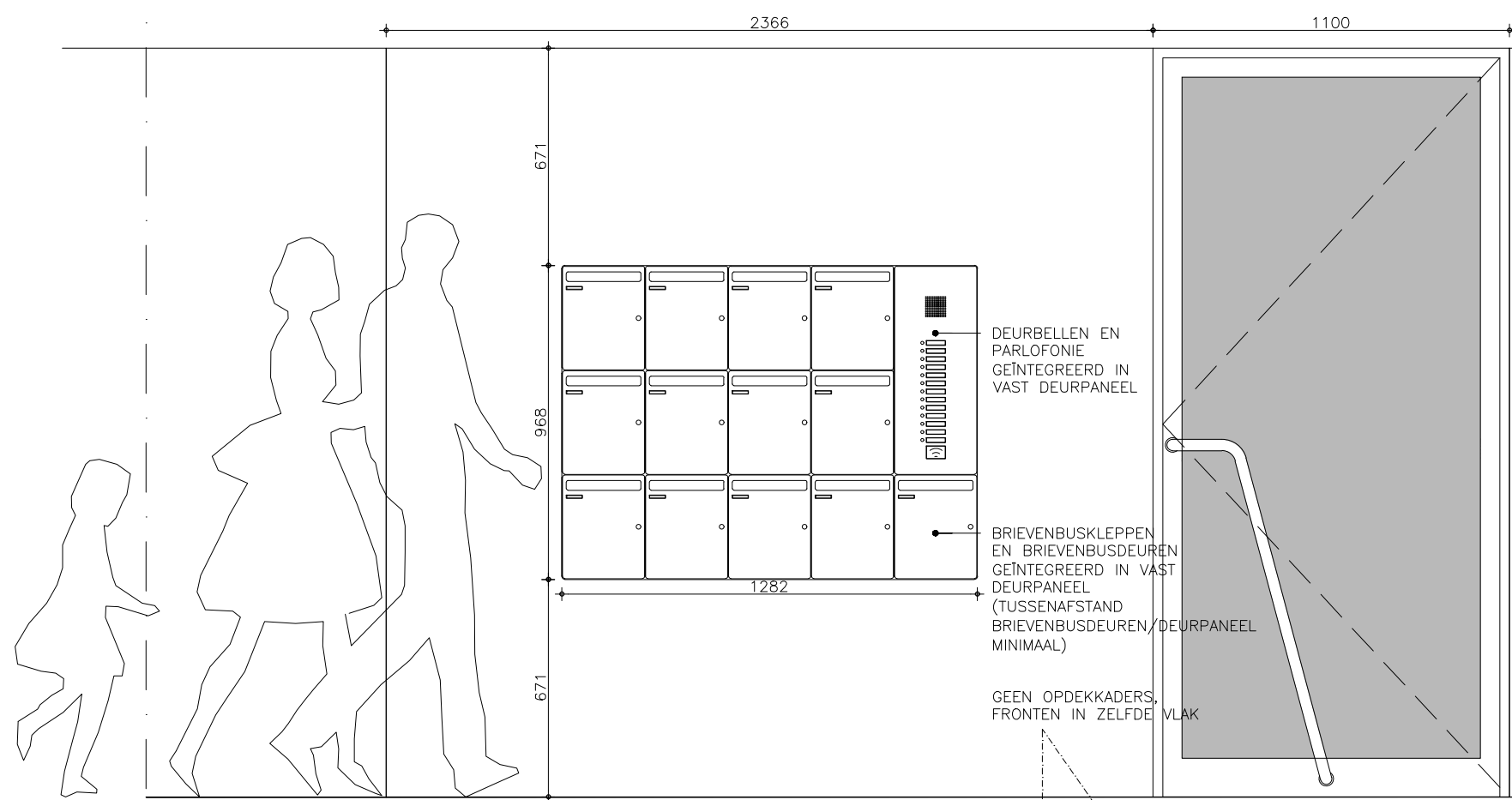

AANZICHT

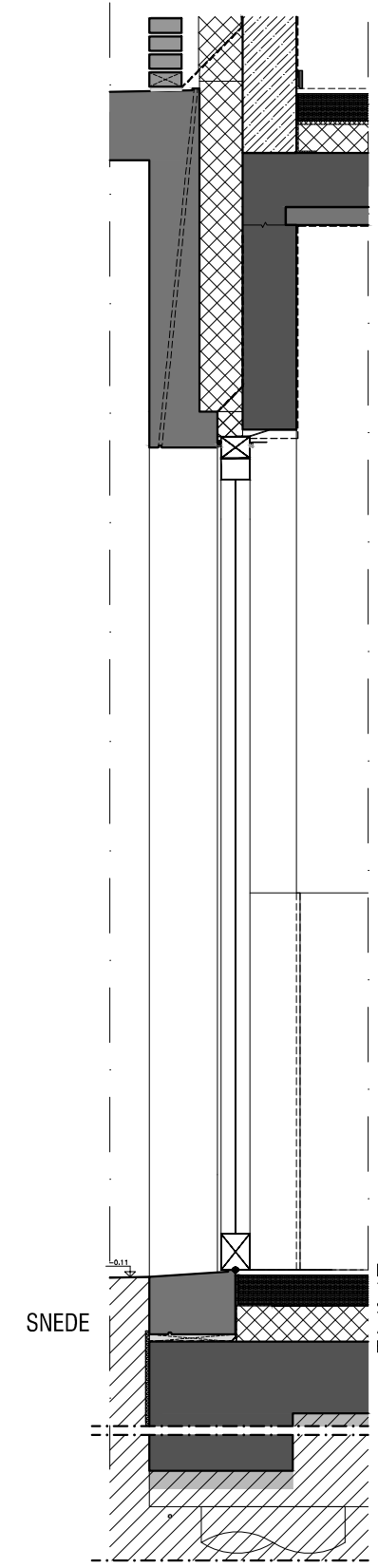
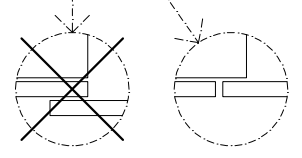

ARCHITECTUUR DE WOLF GOETVINCK HOLVOET JONCKHEERE SPINMOLENPLEIN 192 B-9000 GENT M. +32(0)473.47.29.51 INFO@NET-ARCHITECTUUR.NET	AANBESTEDING - DETAILS	FORMAAT	A3	SCHAAL	1/20
	BUITENSCHRIJNWERK INKOMDEUR BLOK C	DATUM	2024-03-20	GETEKEND	AV
	WIJZIGINGEN	DOSSIER	17.20KKS	TEKENING	A_002
	-				

HEKWERK IN STALEN SPIJLTJES

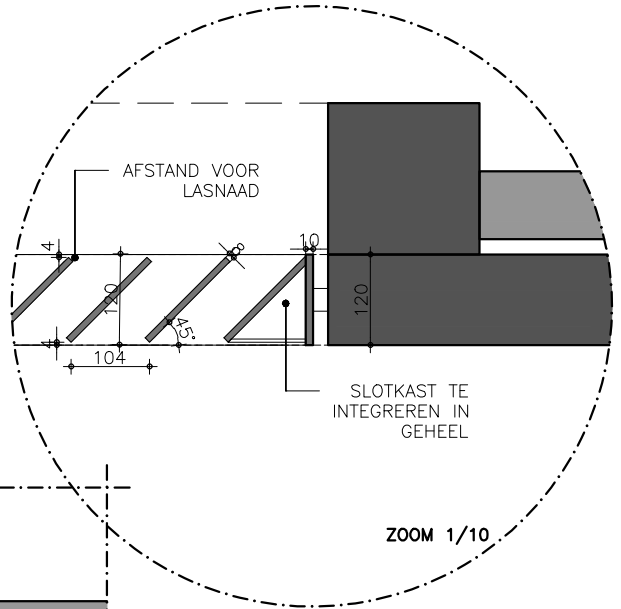
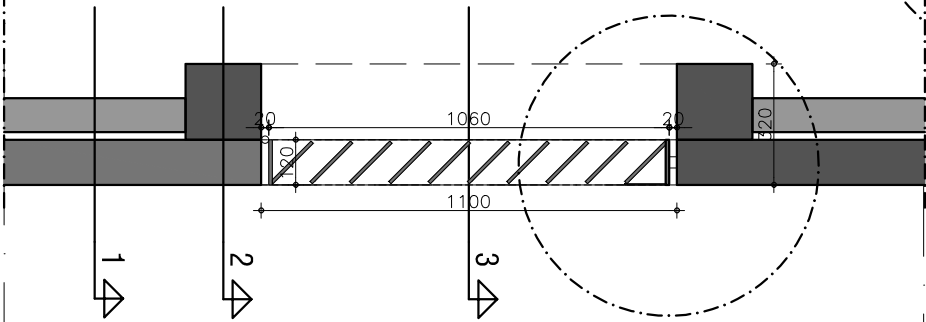

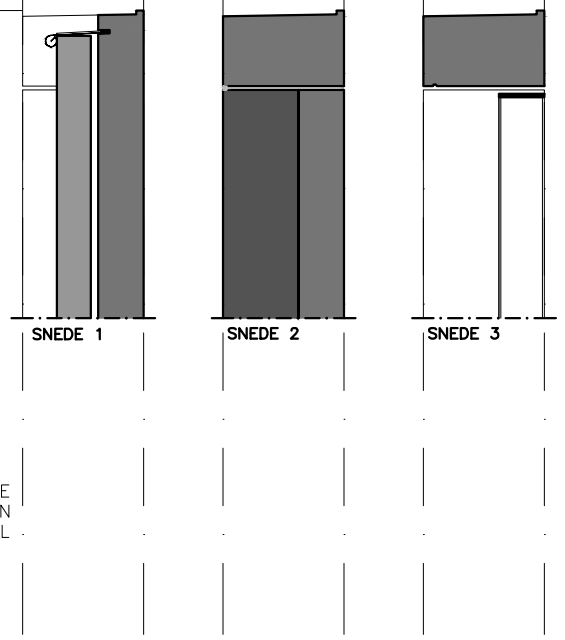
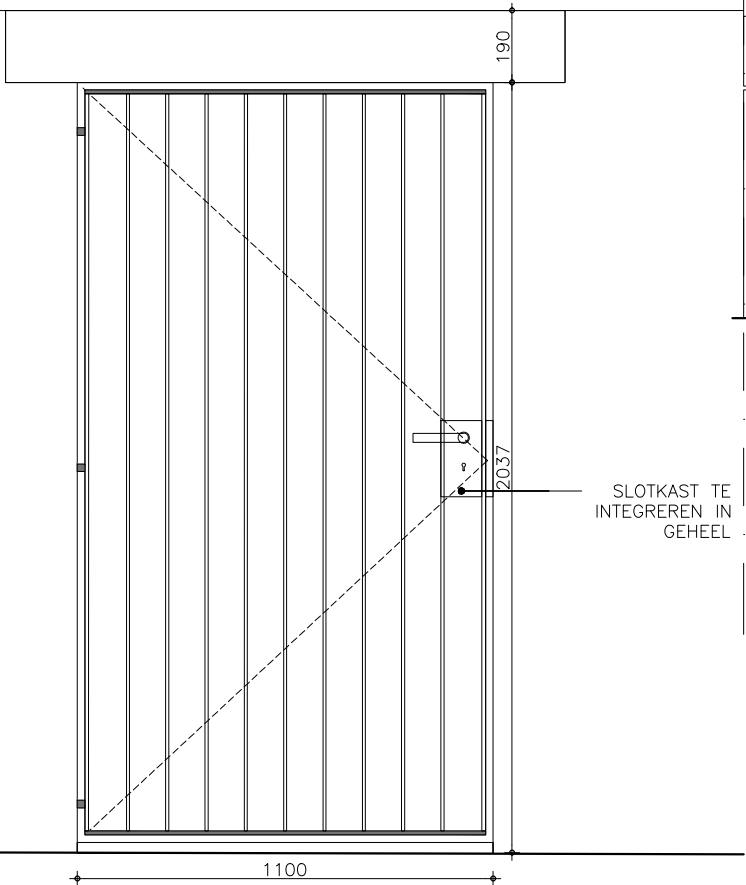

ZOOM 1/10

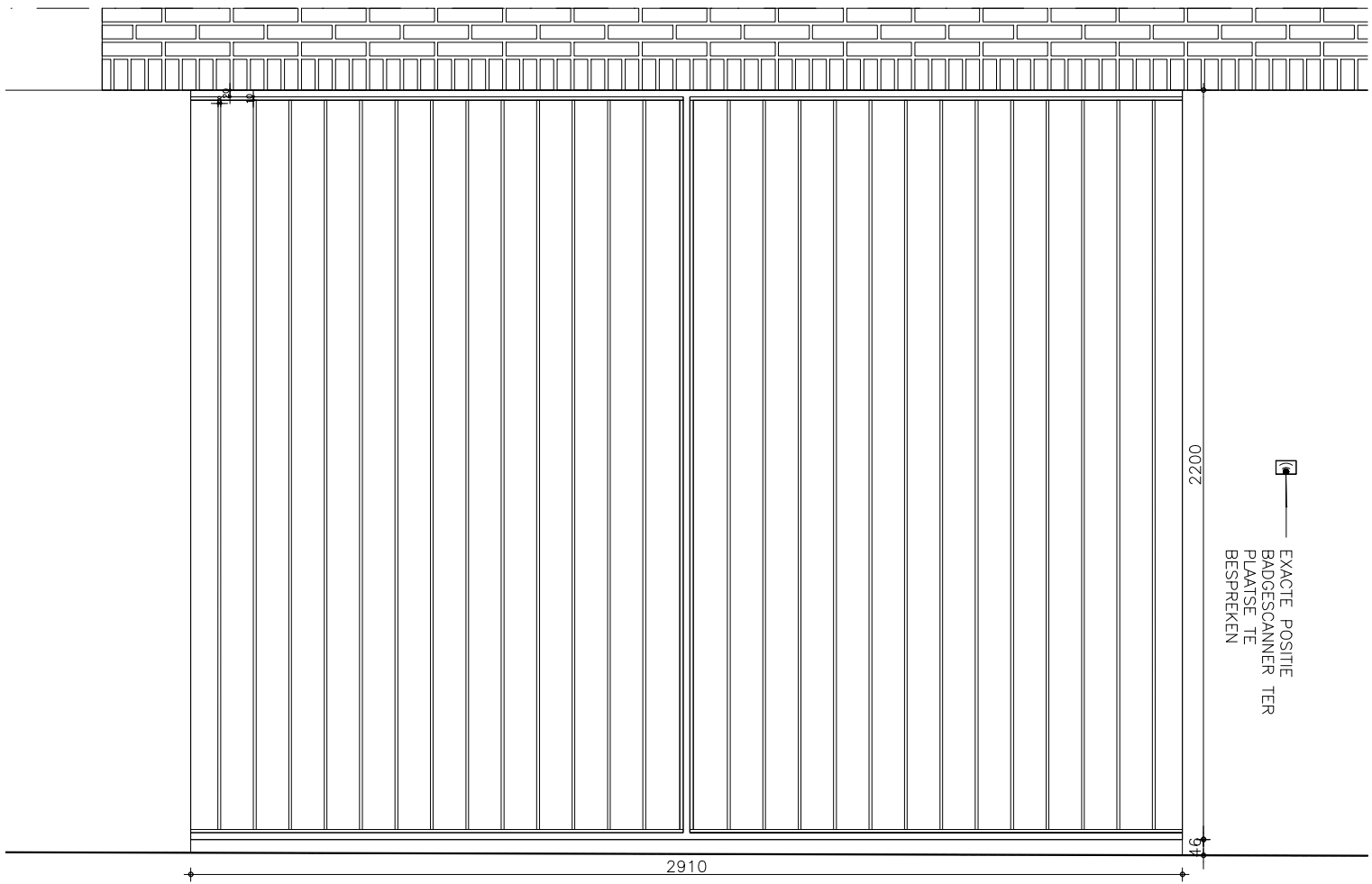
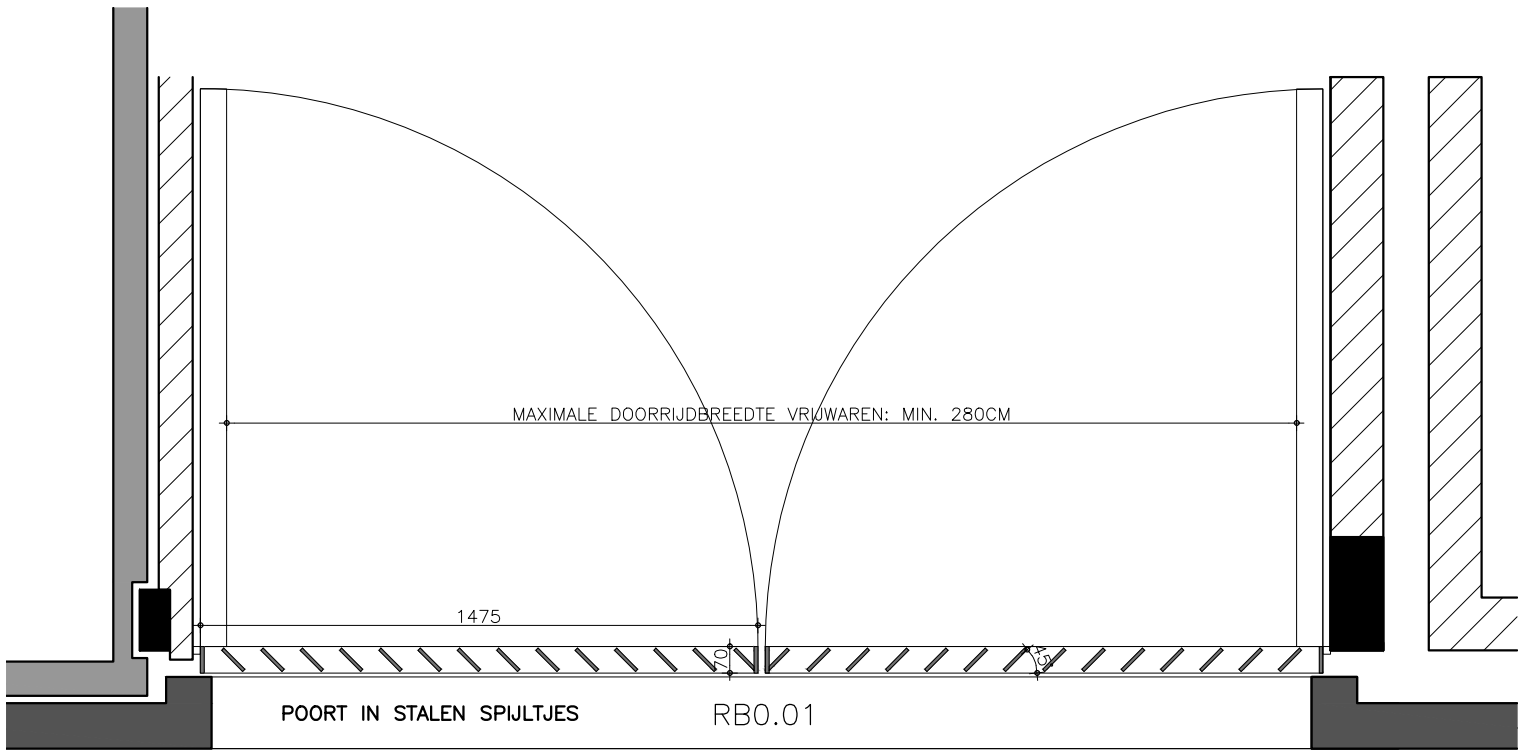

TUINPOORT T1 (TUINPOORT T2 IS SPIEGELBEELD VAN TUINPOORT T1)

 <p>ARCHITECTUUR DE WOLF GOETVINCK HOLVOET JONCKHEERE SPINMOLENPLEIN 192 B-9000 GENT M. +32(0)473.47.29.51 INFO@NET-ARCHITECTUUR.NET</p>	AANBESTEDING - DETAILS	FORMAAT A4	SCHAAL 1/20
	BUITENSCHRIJNWERK TUINPOORT	DATUM 2024-03-20	GETEKEND AV
	WIJZIGINGEN - - -	DOSSIER 17.20KKS	TEKENING A_003



 DE WOLF GOETVINCK HOLVOET JONCKHEERE SPINMOLENPLEIN 192 B-9000 GENT M. +32(0)473.47.29.51 INFO@NET-ARCHITECTUUR.NET	AANBESTEDING - DETAILS	FORMAAT A4	SCHAAL 1/20
	BUITENSCHRIJNWERK GARAGEPOORT	DATUM 2024-03-20	GETEKEND AV
	WIJZIGINGEN - -	DOSSIER 17.20KKS	TEKENING A_004

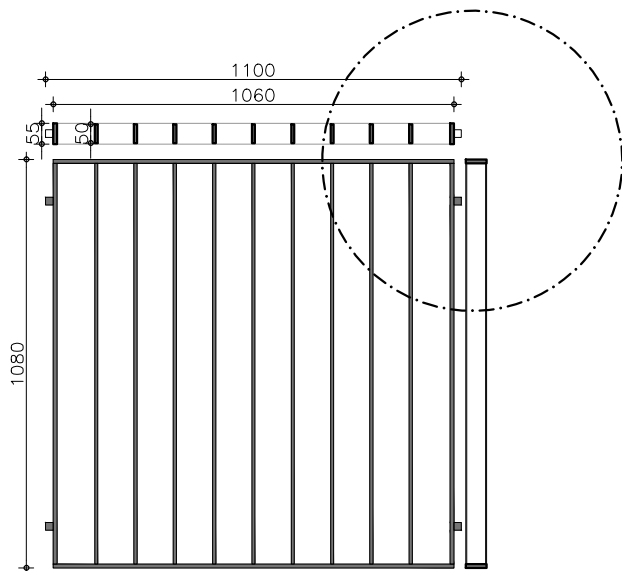

BALUSTRADE IN STALEN SPIJLTJES

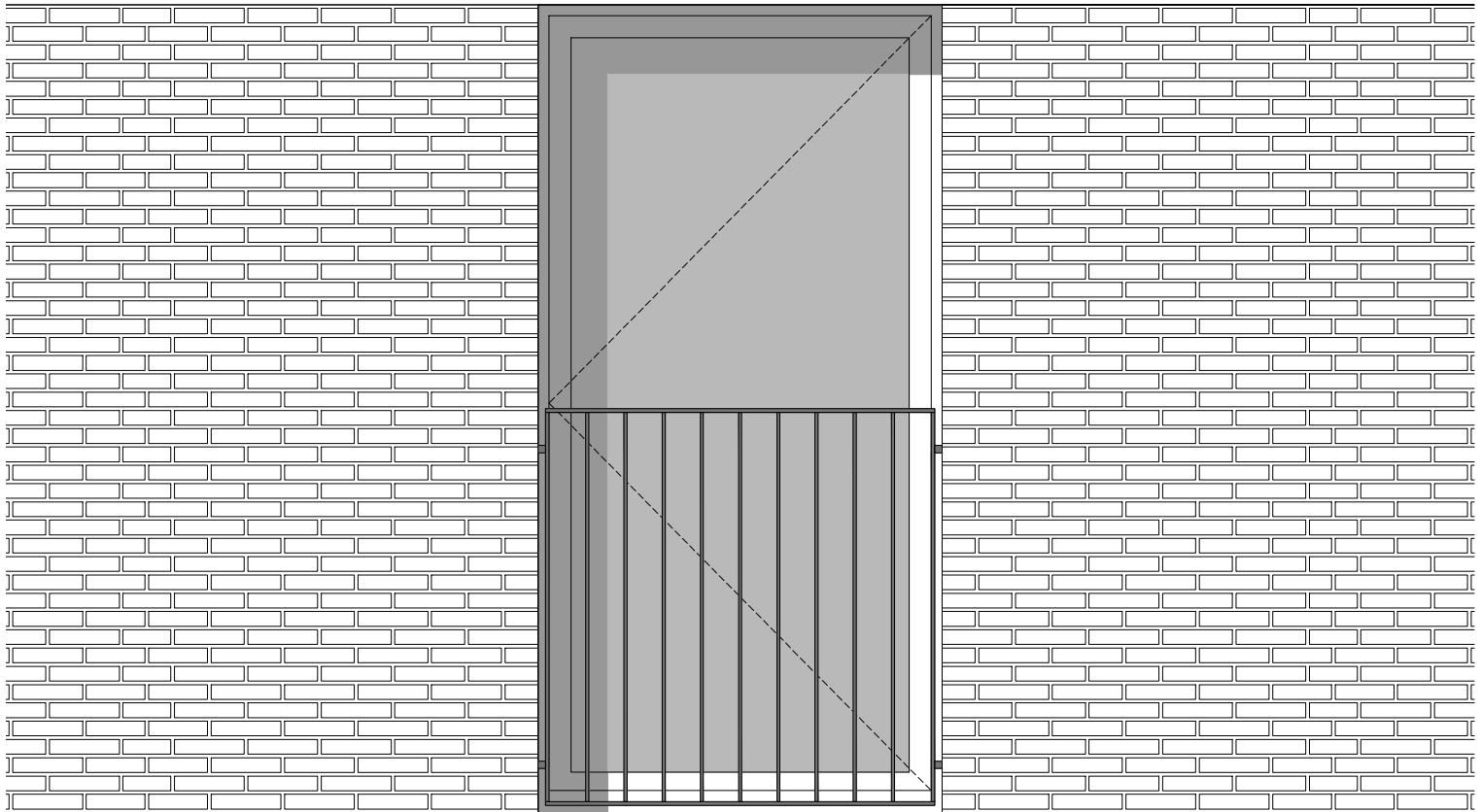
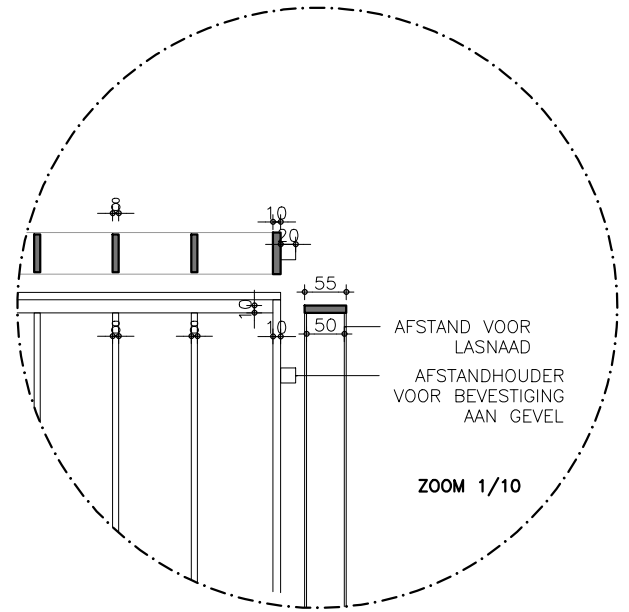

 DE WOLF GOETVINCK HOLVOET JONCKHEERE SPINMOLENPLEIN 192 B-9000 GENT M. +32(0)473.47.29.51 INFO@NET-ARCHITECTUUR.NET	AANBESTEDING - DETAILS	FORMAAT A4	SCHAAL 1/20
	BUITENSCHRIJNWERK BALUSTRADE	DATUM 2024-03-20	GETEKEND AV
	WIJZIGINGEN - -	DOSSIER 17.20KKS	TEKENING A_101

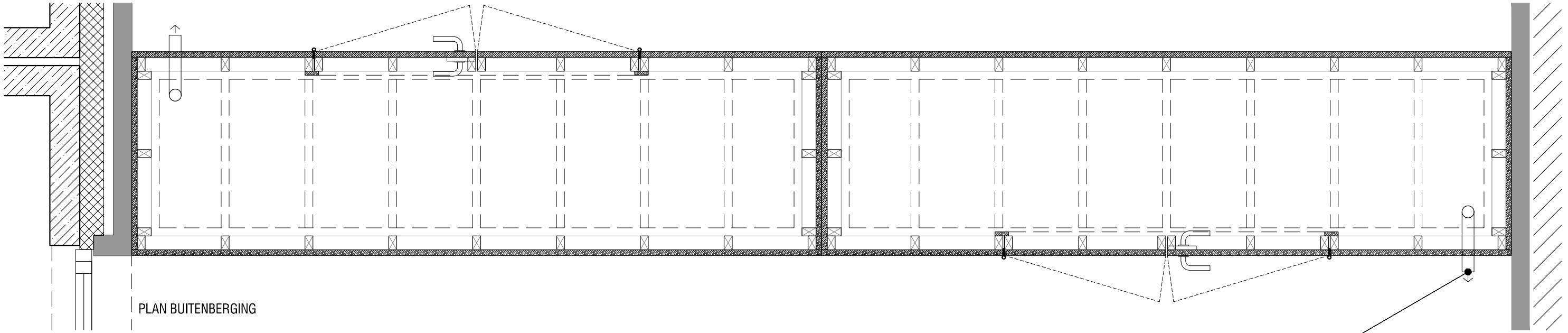

PLAN BUITENBERGING

REGENWATERAFVOER

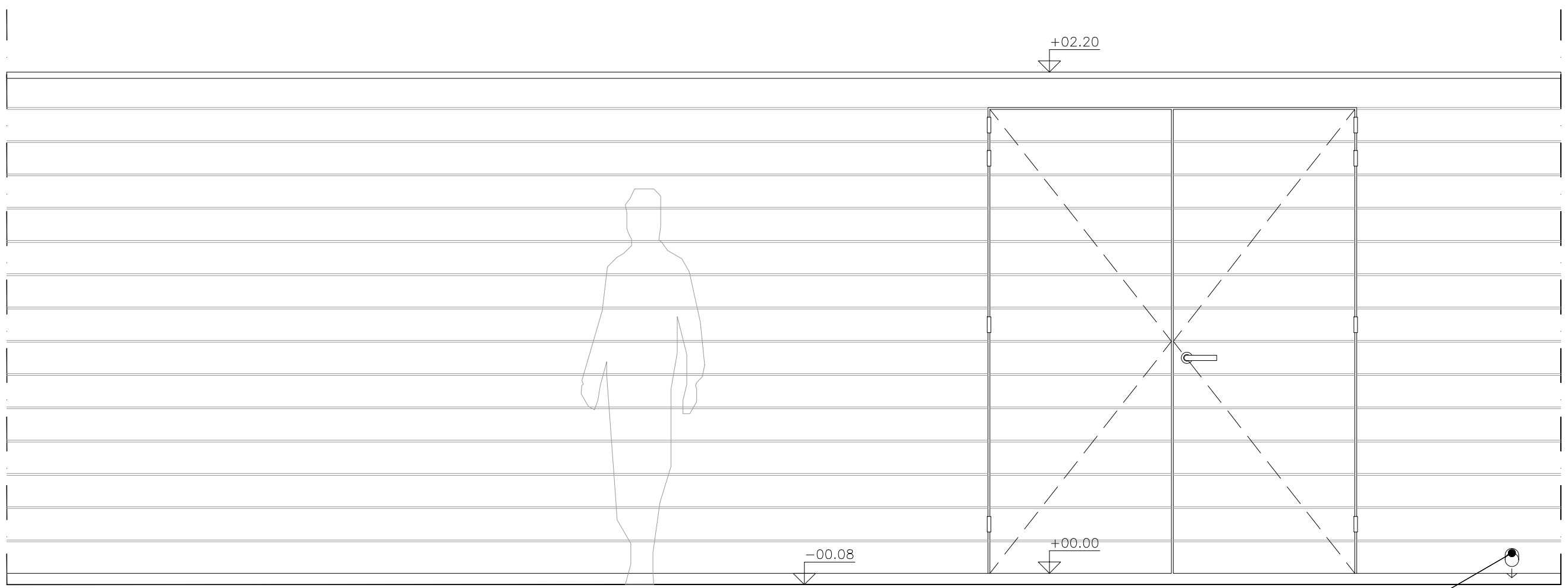

AANZICHT BUITENBERGING

REGENWATERAFVOER

 DE WOLF GOETVINCK HOLVOET JONCKHEERE SPINMOLENPLEIN 192 B-9000 GENT M. +32(0)473.47.29.51 INFO@NET-ARCHITECTUUR.NET	AANBESTEDING - DETAILS	FORMAAT A3	SCHAAL 1/20
	TUINBERGING BLOK A	DATUM 2024-03-20	GETEKEND JJ
	WIJZIGINGEN	DOSSIER	TEKENING
	-	17.20KKS	A_005_1

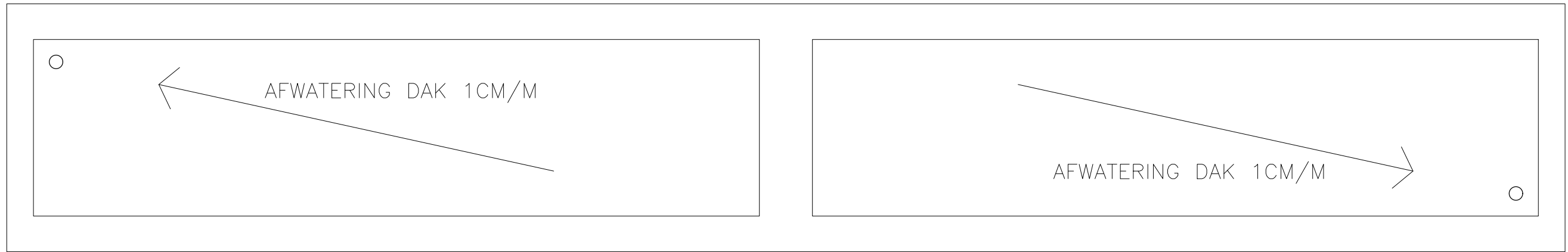

DAKPLAN BUITENBERGING

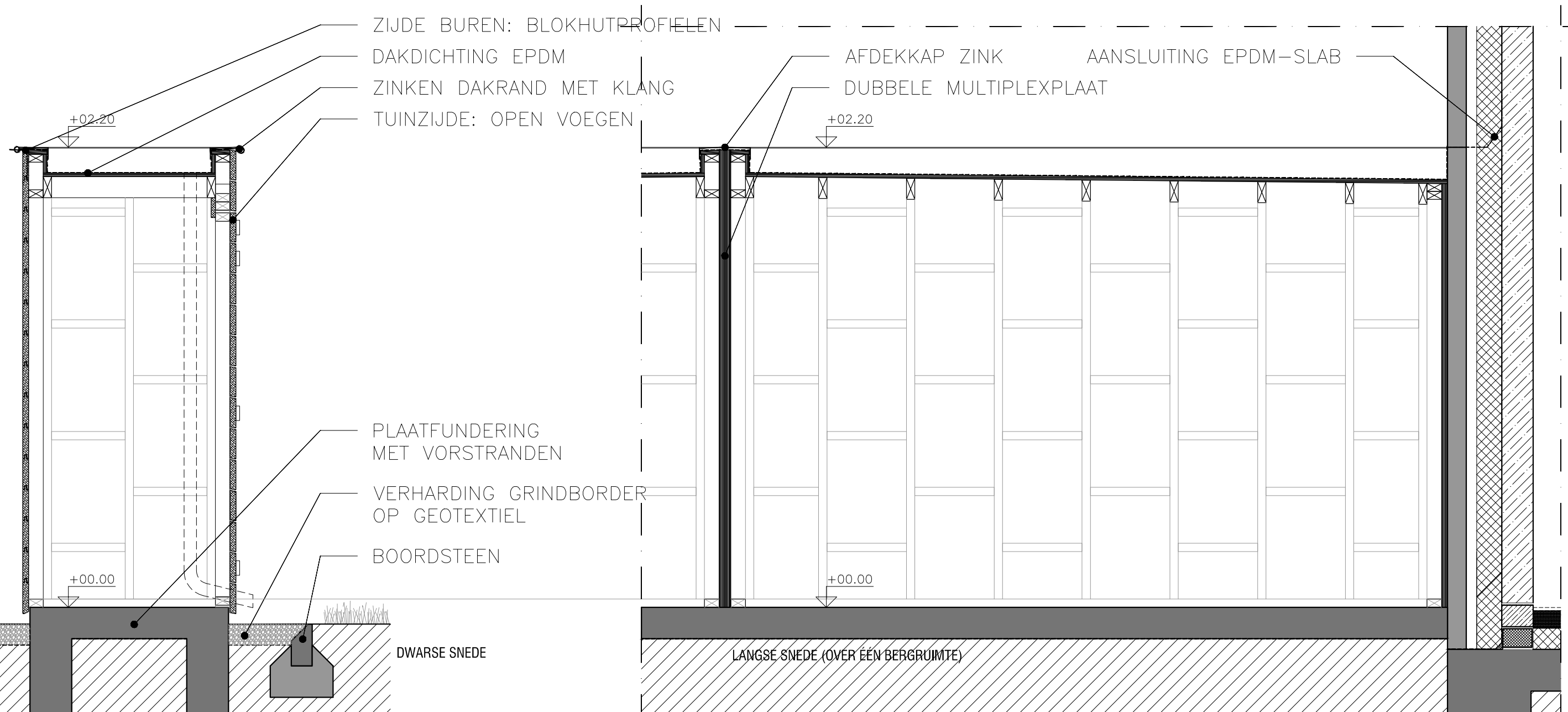

<p>DE WOLF GOETVINCK HOLVOET JONCKHEERE SPINMOLENPLEIN 192 B-9000 GENT M. +32(0)473.47.29.51 INFO@NET-ARCHITECTUUR.NET</p>	AANBESTEDING - DETAILS	FORMAAT A3	SCHAAL 1/20
	TUINBERGING BLOK A	DATUM 2024-03-20	GETEKEND JJ
	WIJZIGINGEN	DOSSIER 17.20KKS	TEKENING A_005_2
	- - -		

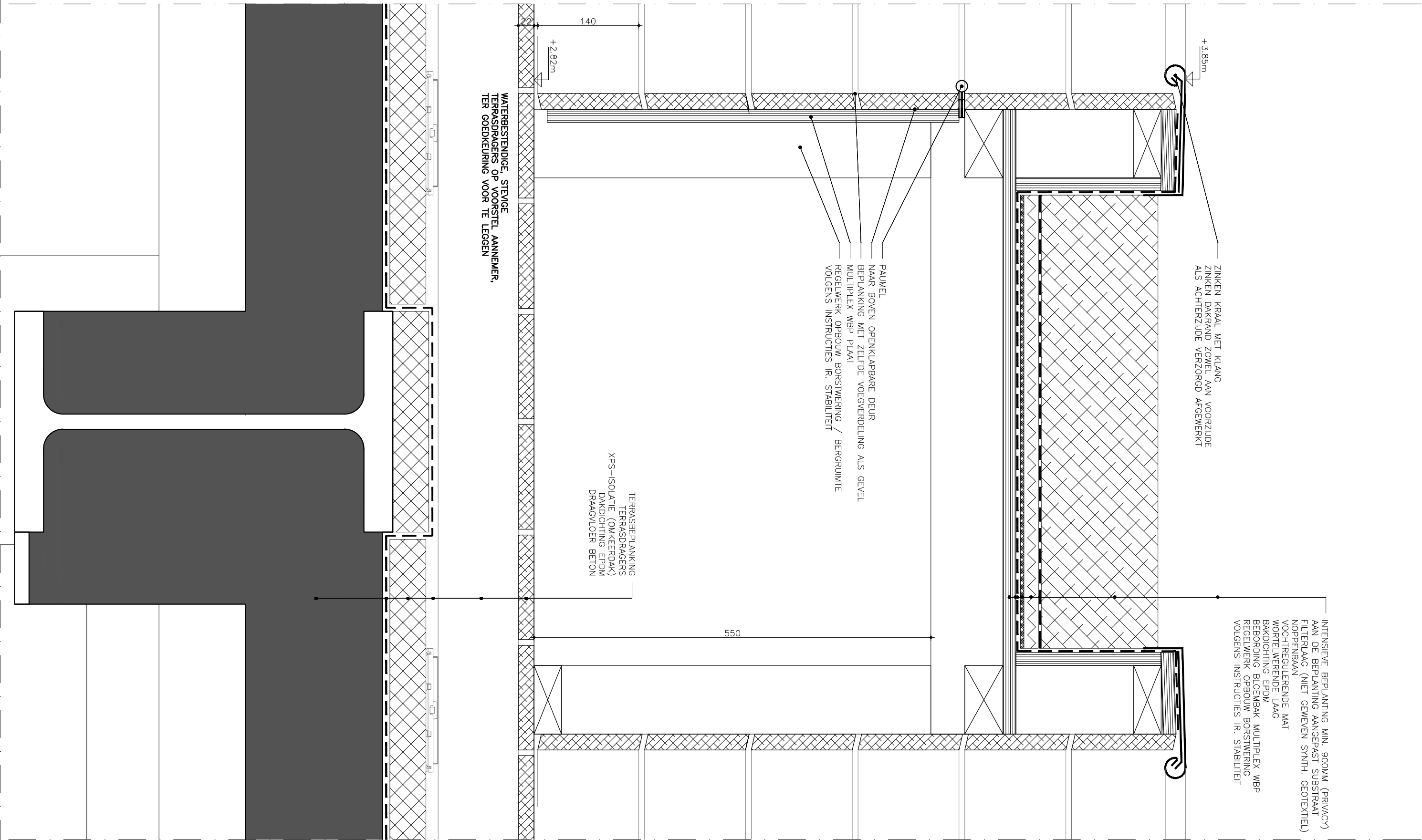

ARCHITECTUUR DE WOLF GOETVINCK HOLVOET JONCKHEERE SPINMOLENPLEIN 192 B-9000 GENT M. +32(0)473.47.29.51 INFO@NET-ARCHITECTUUR.NET	AANBESTEDING - DETAILS	FORMAAT A3	SCHAAL 1/5
	BALUSTRADE/TUINBERGING BLOK A	DATUM 2024-03-20	GETEKEND JJ
	WIJZIGINGEN - - -	DOSSIER 17.20KKS	TEKENING VD_110

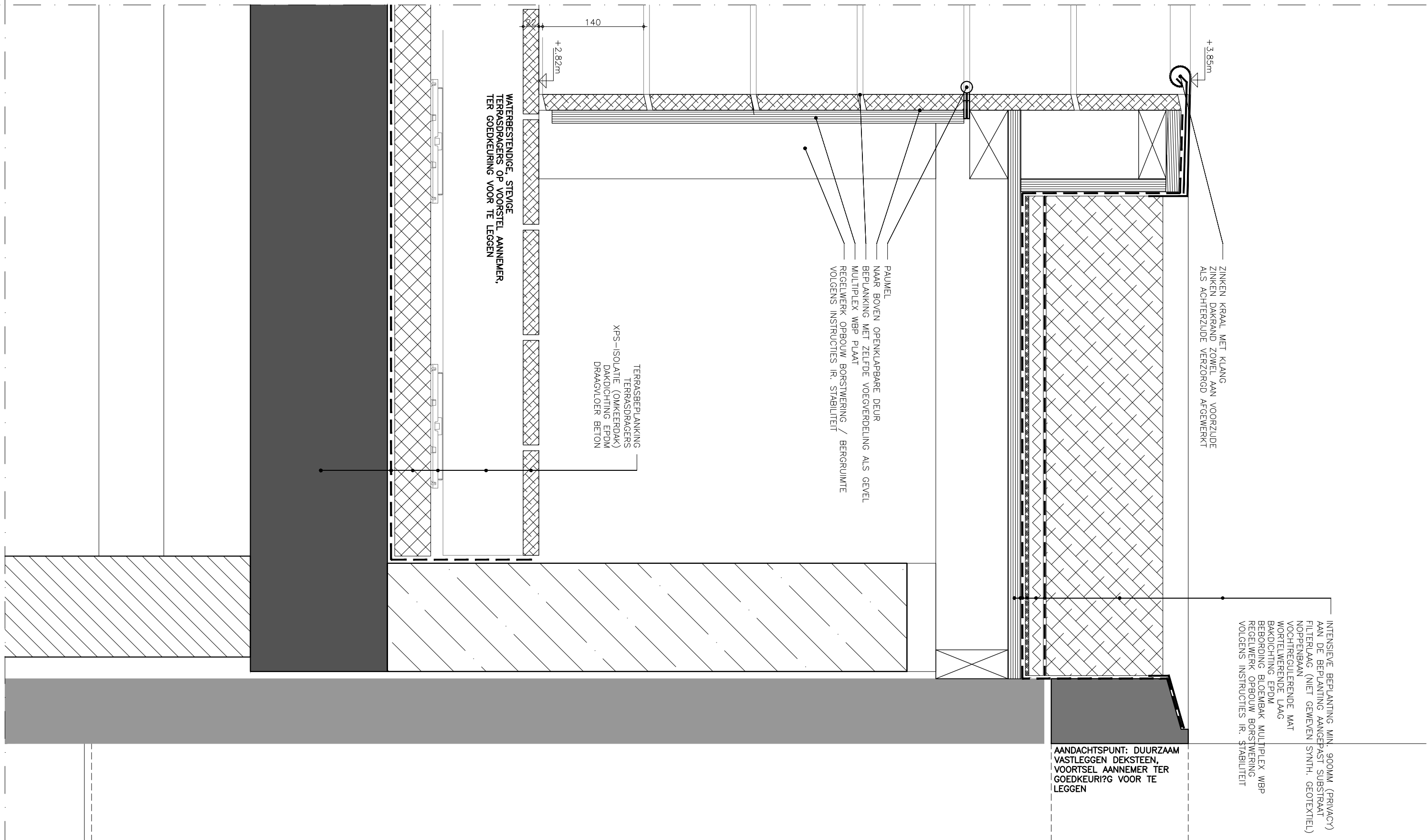

ARCHITECTUUR DE WOLF GOETVINCK HOLVOET JONCKHEERE SPINMOLENPLEIN 192 B-9000 GENT M. +32(0)473.47.29.51 INFO@NET-ARCHITECTUUR.NET	AANBESTEDING - DETAILS	FORMAAT A3	SCHAAL 1/5
	BALUSTRADE/TUINBERGING BLOK A	DATUM 2024-03-20	GETEKEND JJ
	WIJZIGINGEN - - -	DOSSIER 17.20KKS	TEKENING VD_111

KEUKENTYPE C12_C13_C22_C23_C32_C33

NIET-GETEKENDE OVERIGE KEUKENS
VOLGENS ZELFDE PRINCIPE

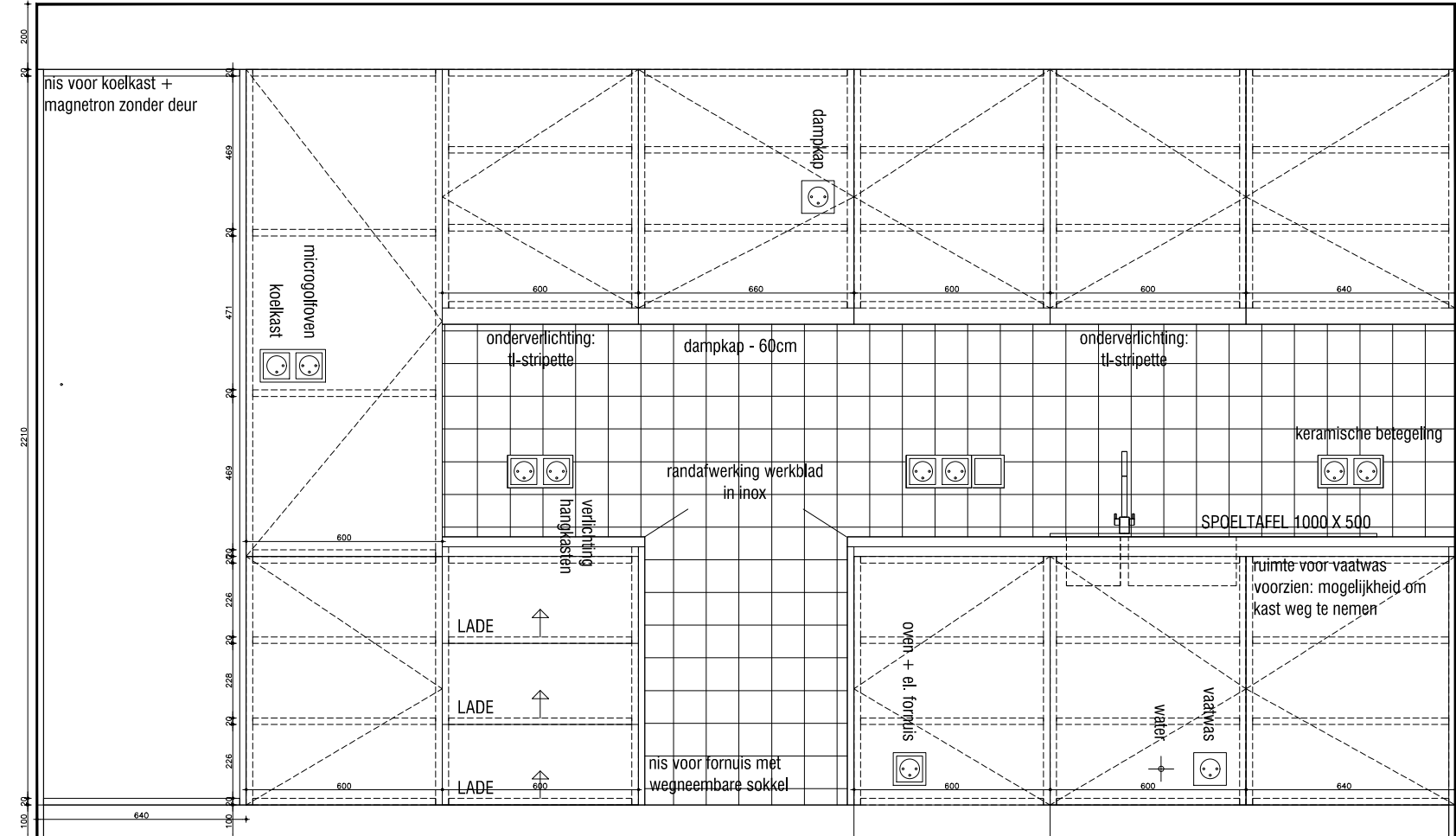
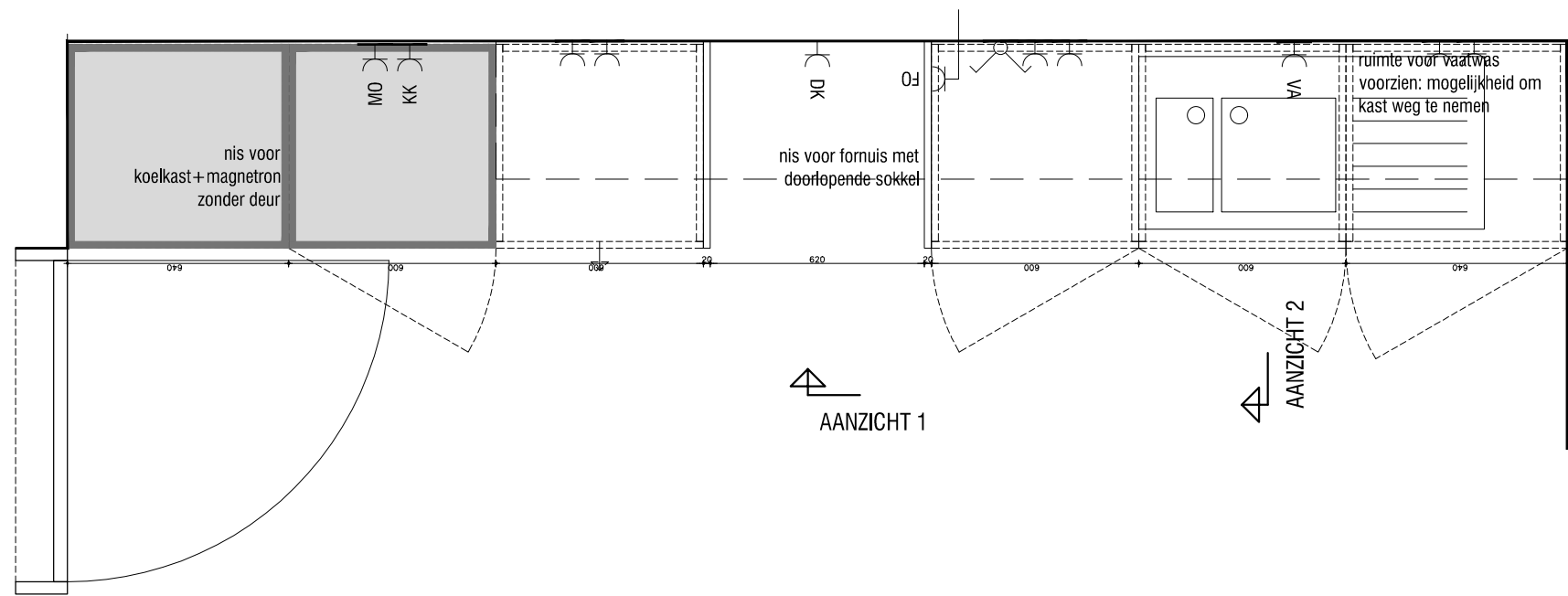

AANZICHT 1

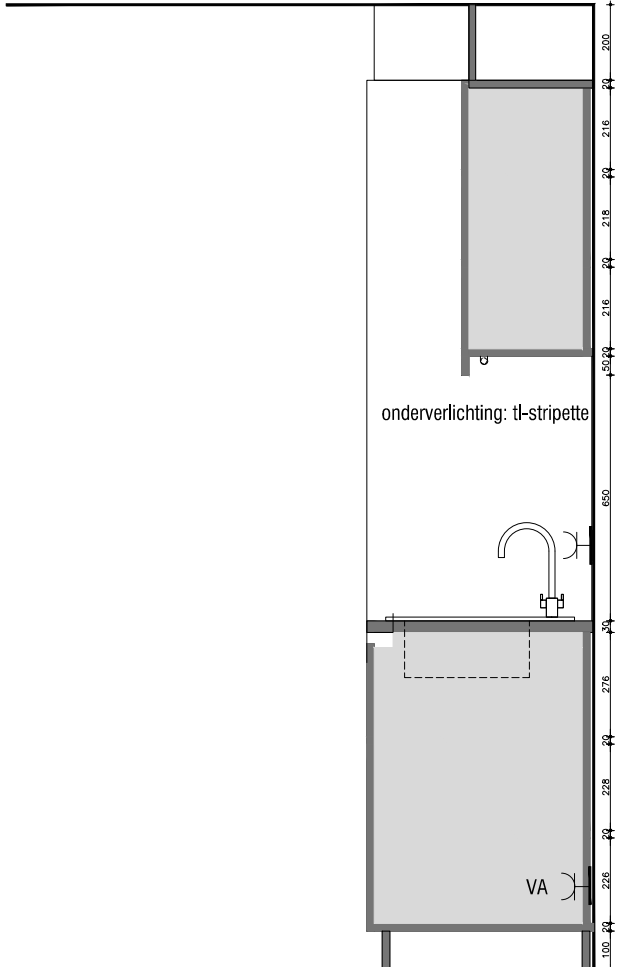

AANZICHT 2

<p>DE WOLF GOETVINCK HOLVOET JONCKHEERE SPINMOLENPLEIN 192 B-9000 GENT M. +32(0)473.47.29.51 INFO@NET-ARCHITECTUUR.NET</p>	AANBESTEDING - DETAILS	FORMAAT A3	SCHAAL 1/20
	KEUKENTYPE 1	DATUM 2024-03-20	GETEKEND AV
	WIJZIGINGEN	DOSSIER	TEKENING
	-	17.20KKS	K01

KEUKENTYPE A_23

NIET-GETEKENDE OVERIGE KEUKENS
VOLGENS ZELFDE PRINCIPE

GRONDPLAN

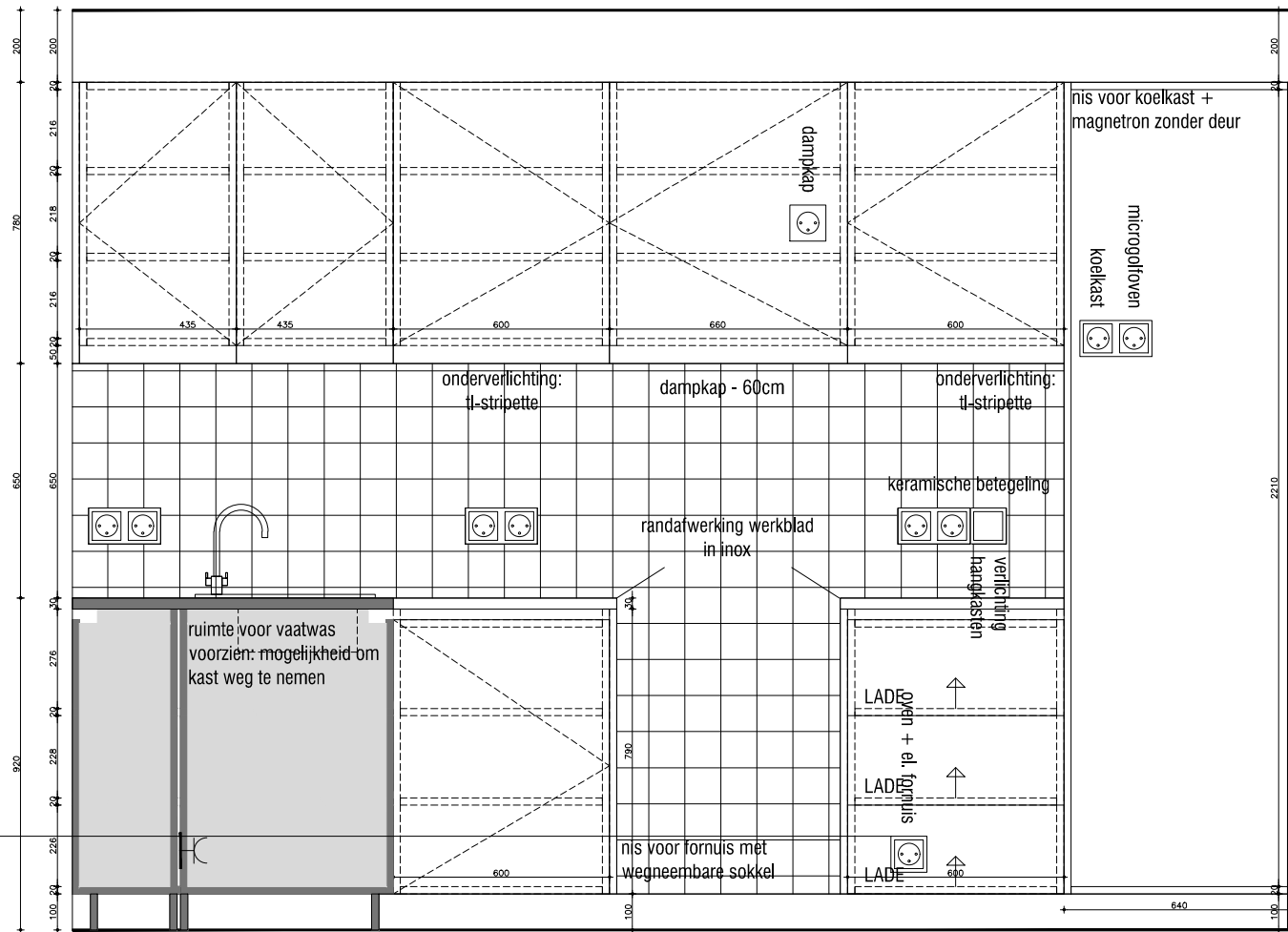
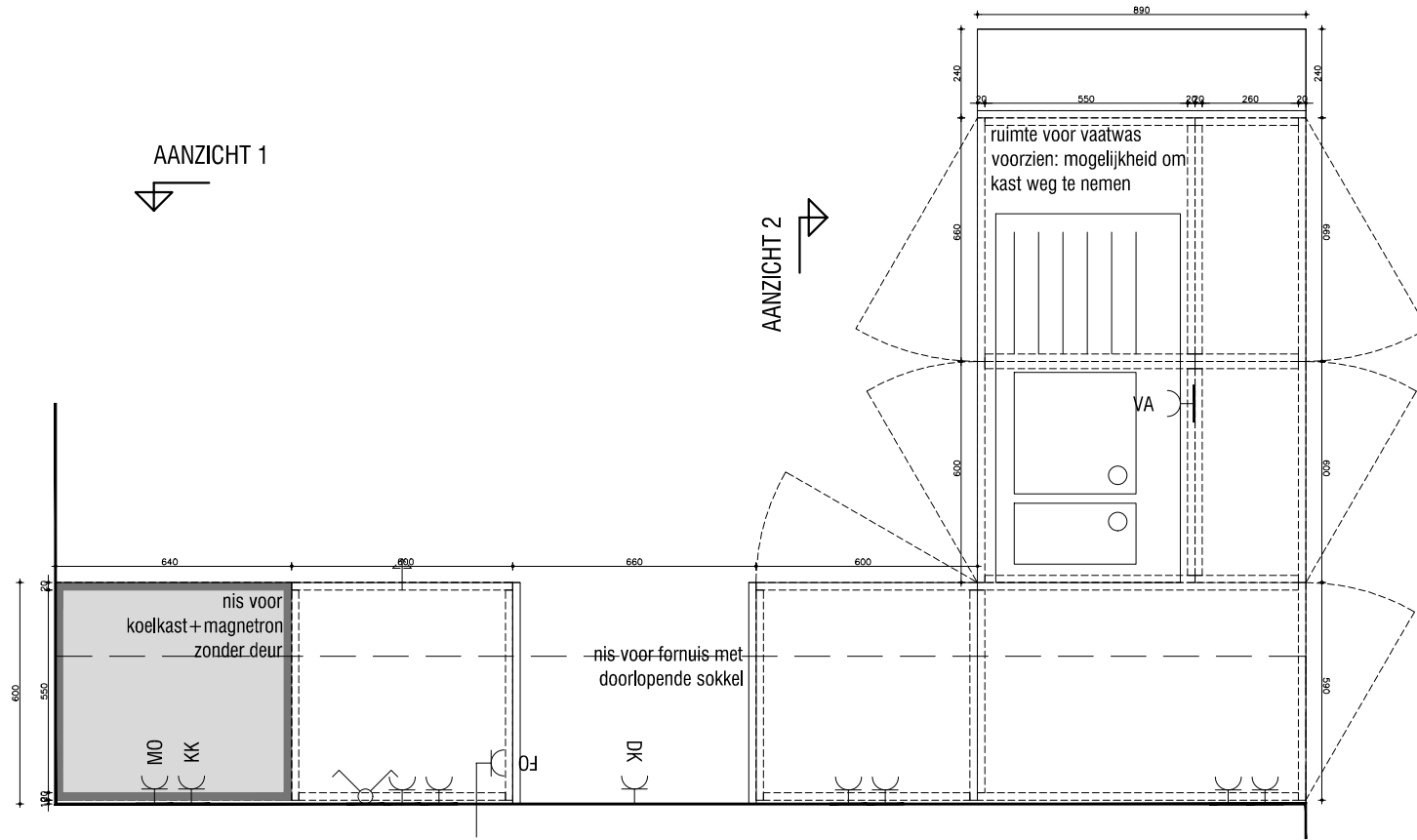

AANZICHT 1

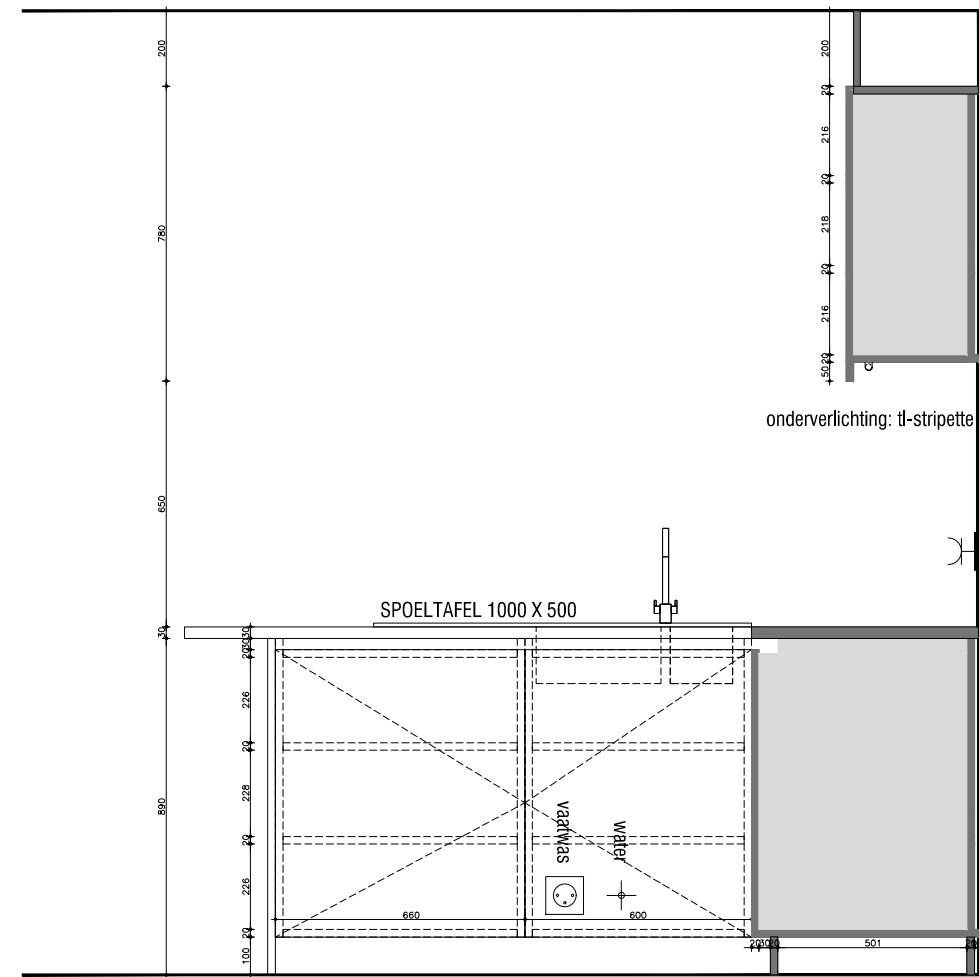

AANZICHT 2

<p>DE WOLF GOETVINCK HOLVOET JONCKHEERE SPINMOLENPLEIN 192 B-9000 GENT M. +32(0)473.47.29.51 INFO@NET-ARCHITECTUUR.NET</p>	AANBESTEDING - DETAILS	FORMAAT	A3	SCHAAL	1/20
	KEUKENTYPE 2	DATUM	2024-03-20	GETEKEND	AV
	WIJZIGINGEN	DOSSIER	17.20KKS	TEKENING	K02
	-				

GRONDPLAN

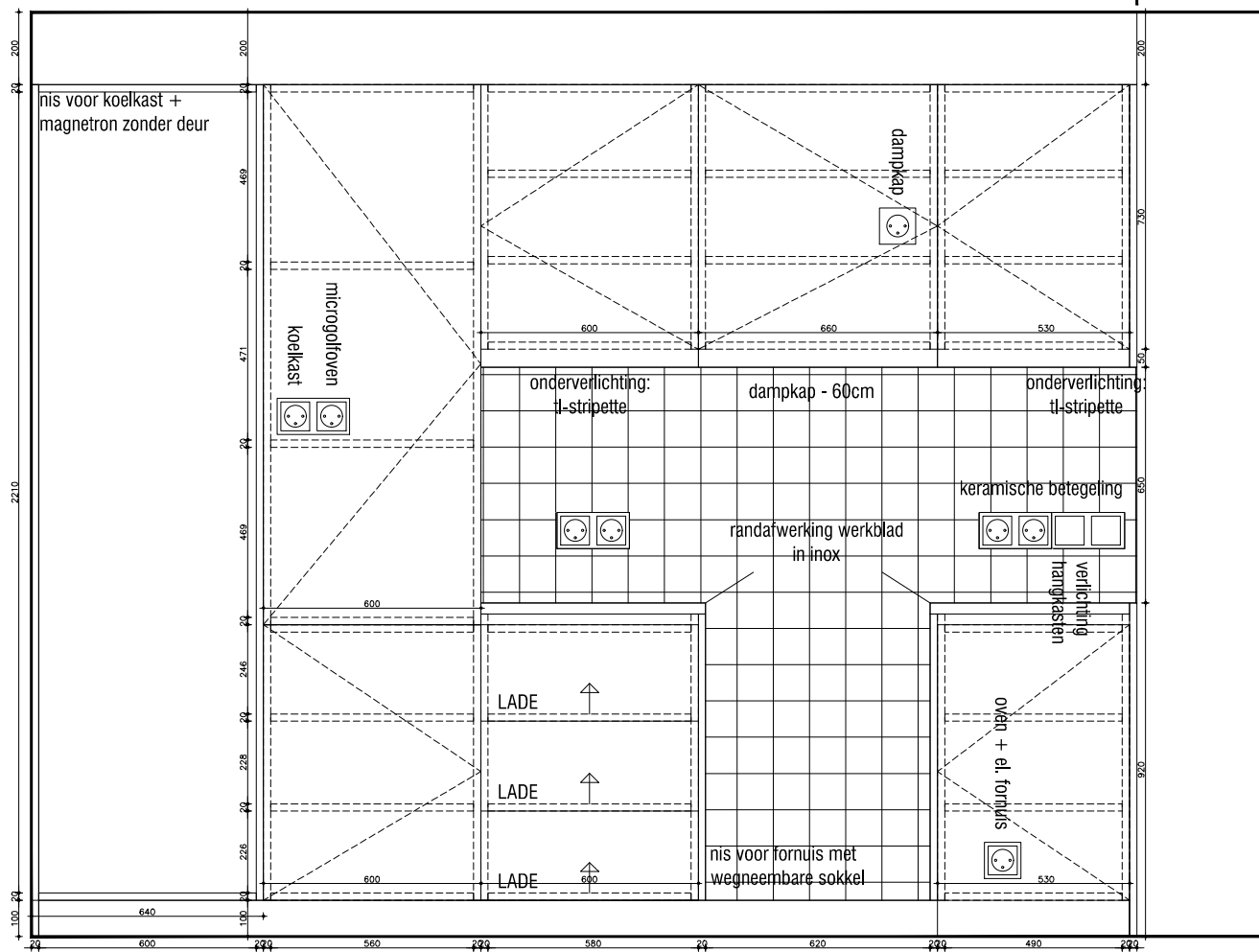
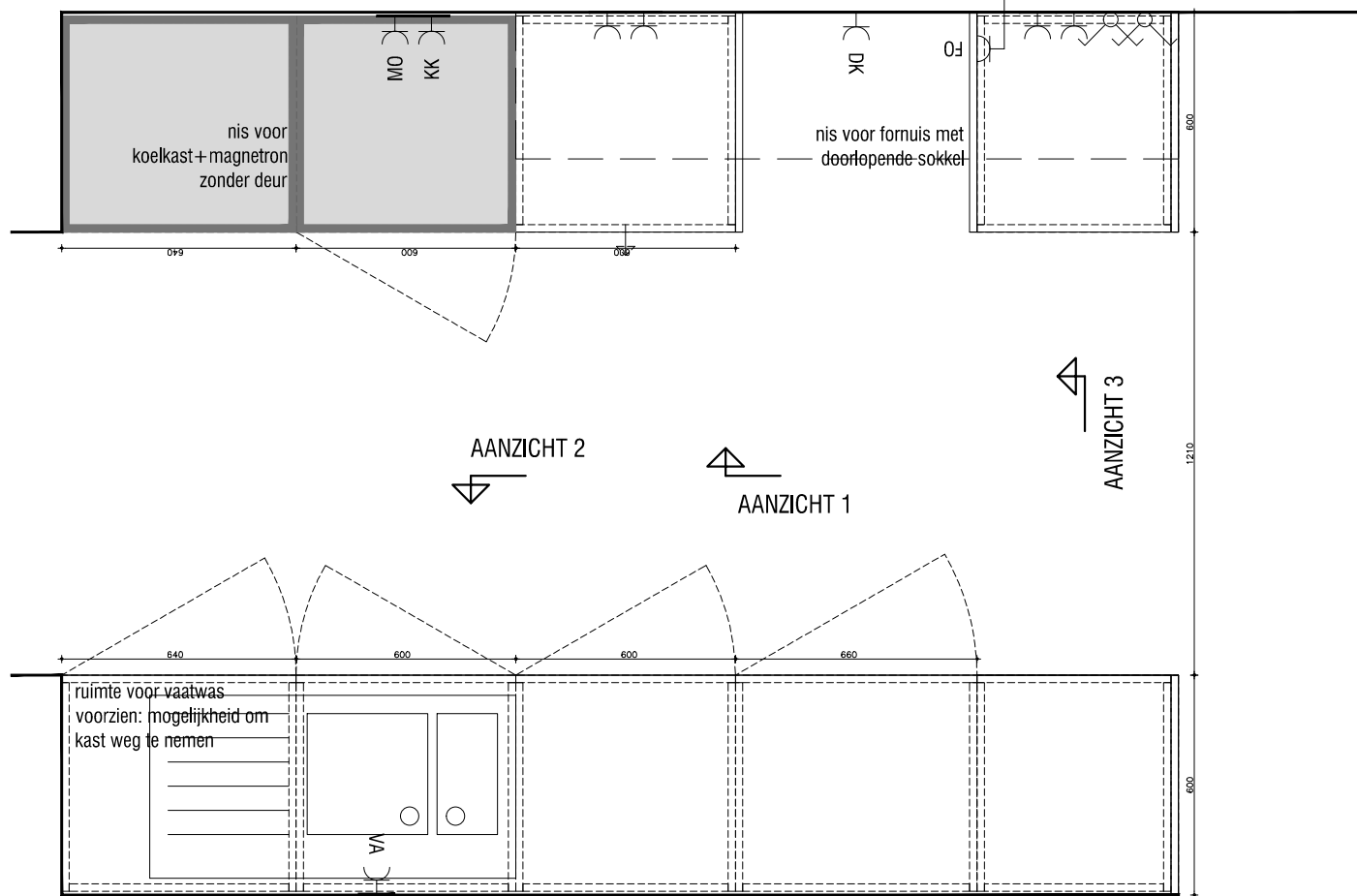

AANZICHT 1

KEUKENTYPE A12_A32
NIET-GETEKENDE OVERIGE KEUKENS
VOLGENS ZELFDE PRINCIPE

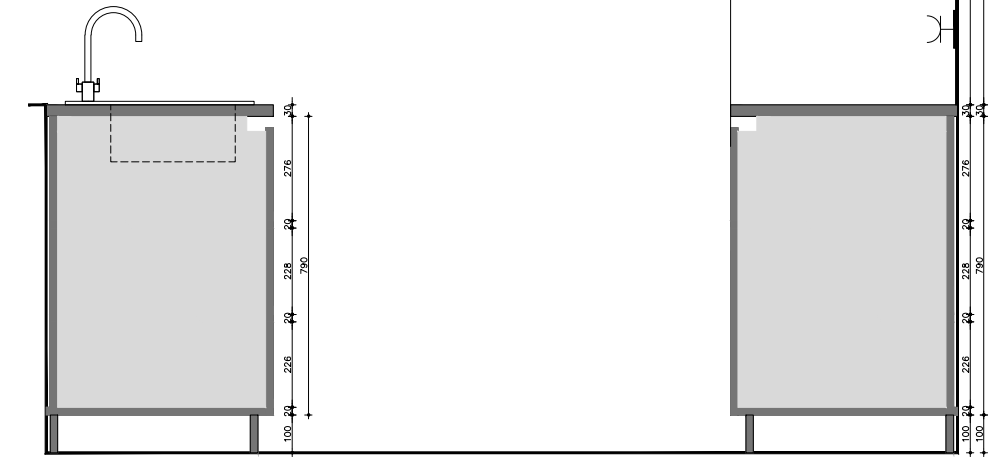

AANZICHT 3

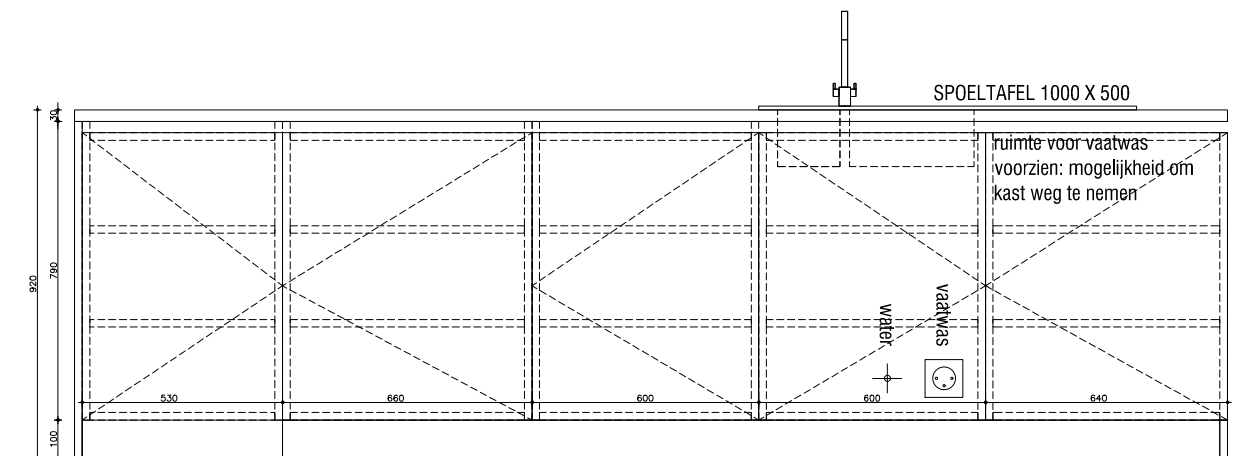

AANZICHT 2

<p>DE WOLF GOETVINCK HOLVOET JONCKHEERE SPINMOLENPLEIN 192 B-9000 GENT M. +32(0)473.47.29.51 INFO@NET-ARCHITECTUUR.NET</p>	AANBESTEDING - DETAILS	FORMAAT A3	SCHAAL 1/20
	KEUKENTYPE 3	DATUM 2024-03-20	GETEKEND AV
	WIJZIGINGEN	DOSSIER	TEKENING
	- - -	17.20KKS	K03

KEUKENTYPE B1_B2_B3_B4
 NIET-GETEKENDE OVERIGE KEUKENS
 VOLGENS ZELFDE PRINCIPE

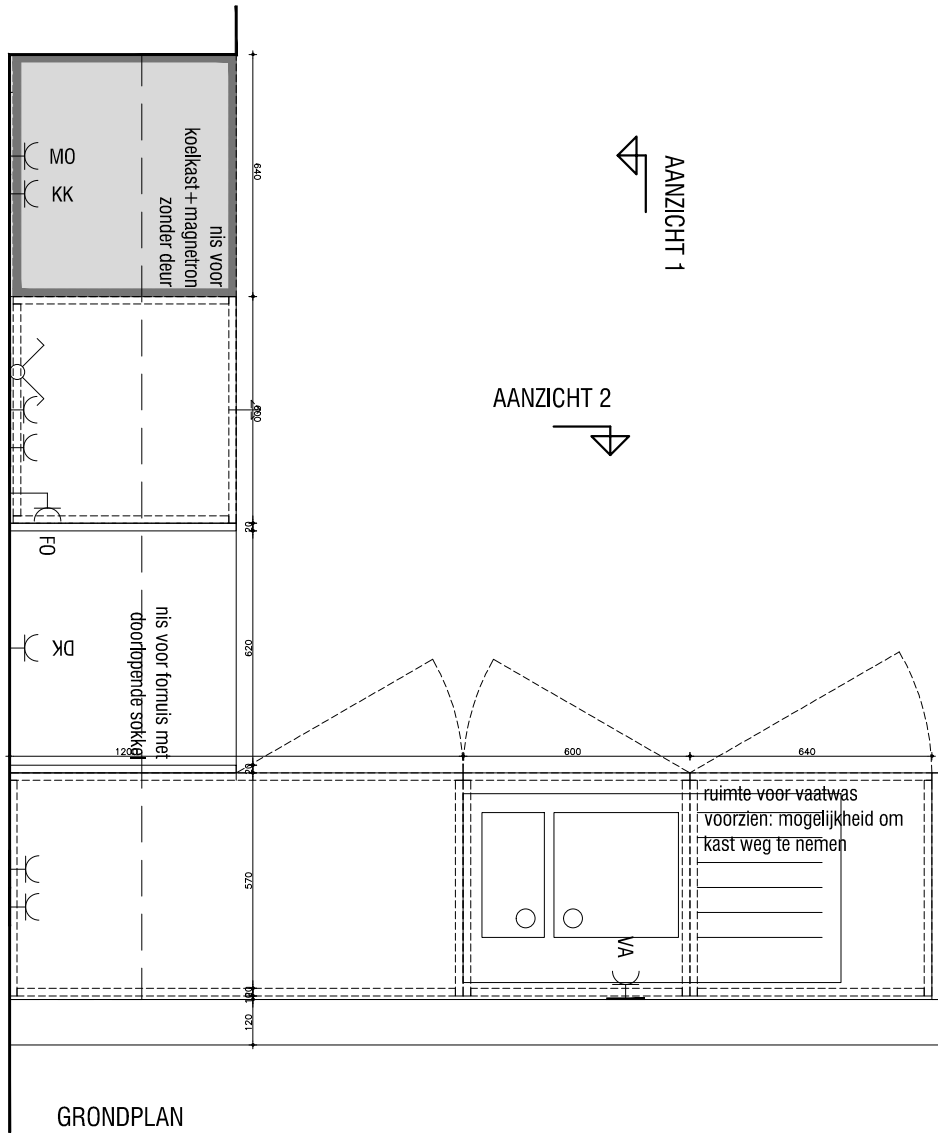

AANZICHT 1

AANZICHT 2

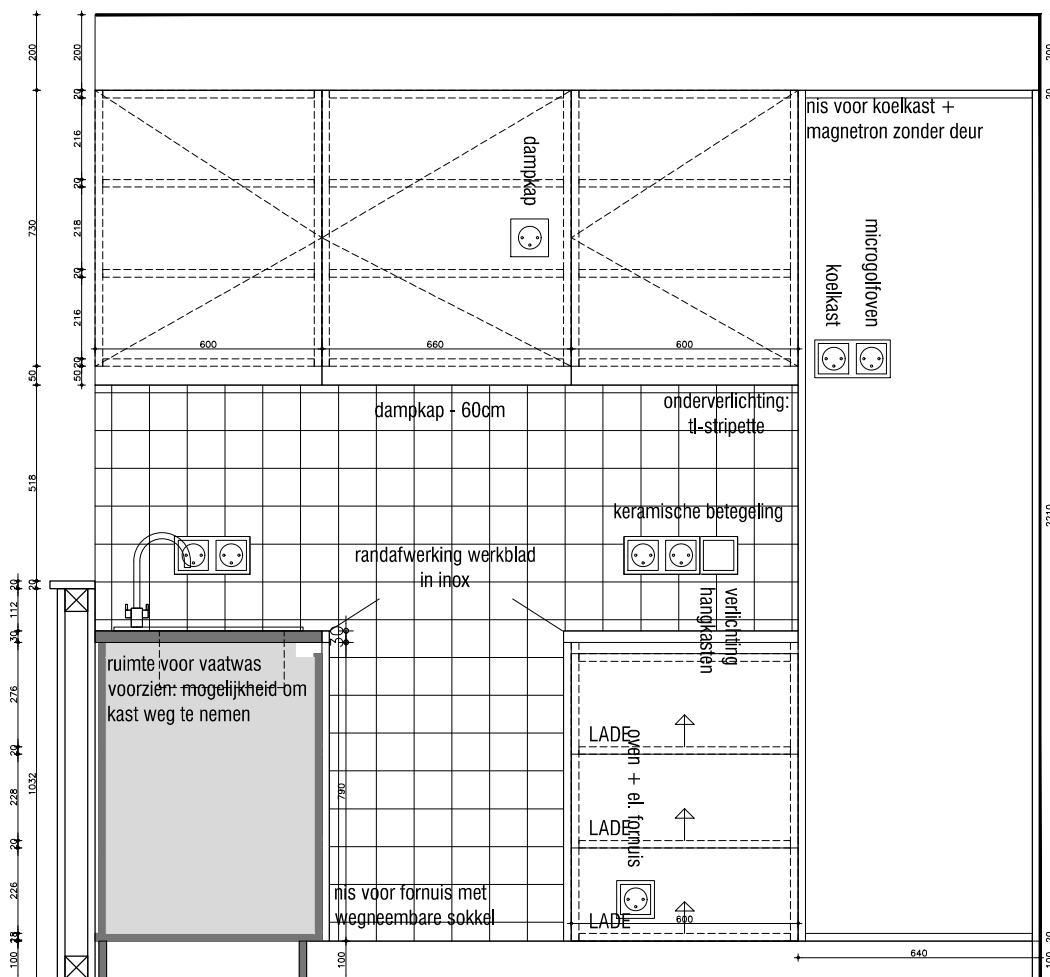

AANZICHT 1

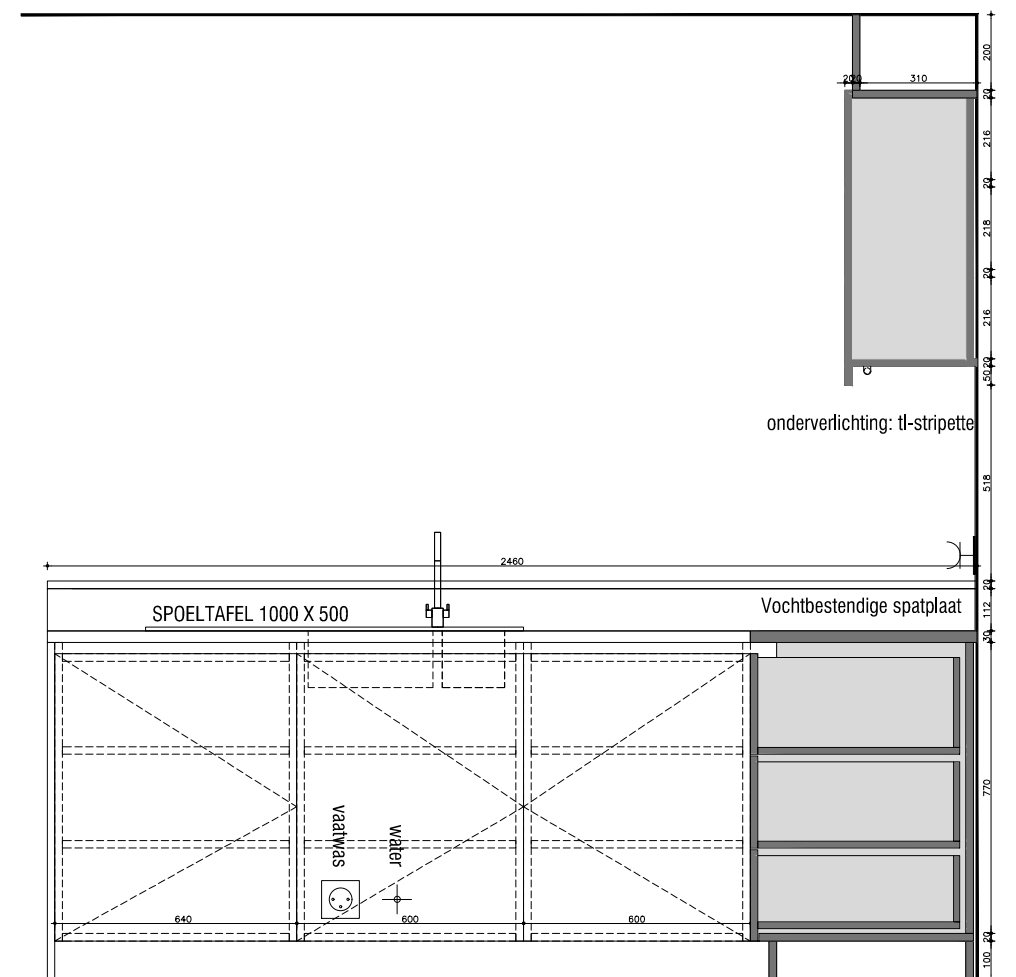

AANZICHT 2

<p>DE WOLF GOETVINCK HOLVOET JONCKHEERE SPINMOLENPLEIN 192 B-9000 GENT M. +32(0)473.47.29.51 INFO@NET-ARCHITECTUUR.NET</p>	AANBESTEDING - DETAILS	FORMAAT	A3	SCHAAL	1/20
	KEUKENTYPE 4	DATUM	2024-03-20	GETEKEND	AV
	WIJZIGINGEN	DOSSIER	TEKENING		
	- - -	17.20KKS	K04		

GEMEENSCHAPPELIJK LOKAAL BLOK A

- OPSTELLING IN GEMEENSCHAPPELIJK LOKAAL, CFR. VOORSCHRIFTEN FARYS - IB TYPE 2 (INDIVUELE BEMETERING NA HOOFDWATERMETER MET GEGROEPEERDE CENTRALE OPSTELLING).
- NOODZAAK DRUKVERHOOGING NA TE GAAN (MINSTENS 2,5BAR TE VOORZIEN IN ELK APPARTEMENT).

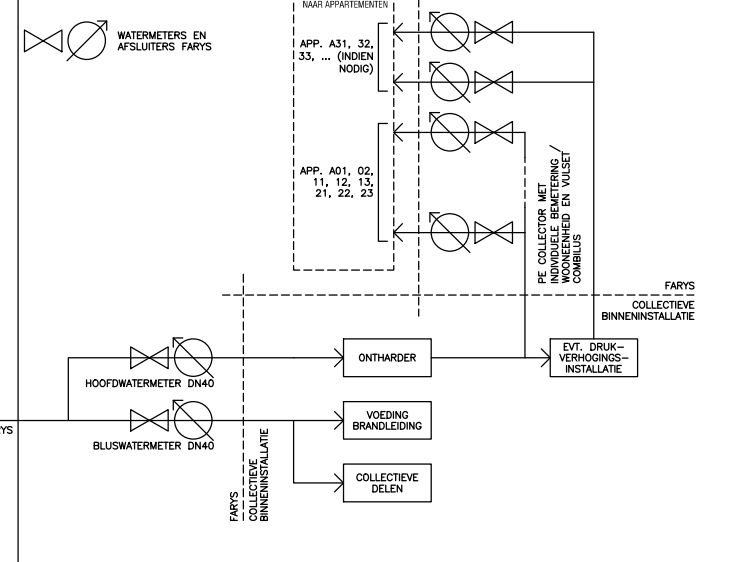

SCHEMATISCHE WEERGAVE AANSLUITINGEN WATER

GEMEENSCHAPPELIJK LOKAAL BLOK B

DE HYDRAULISCHE SCHEMA'S VAN DE COMBILUS EN DE WATERTELLERS MOETEN ALS SCHEMATISCHE WEERGAVE GEZIEN WORDEN DIE DIENEN OM DE INSTALLATIE INZICHTELIJKER TE MAKEN. EEN EVENTUELE WIJZIGING IN DEZE SCHEMA'S GEEFT GEEN AANLEIDING TOT PRIJSWIJZIGING INDIEN DE AANTALLEN VAN DE ONDERDELEN ONGEWIJZIGD BLIJVEN. WIJZIGINGEN IN LEIDINGLENGTES GEVEN GEEN AANLEIDING TOT VERREKENINGEN, AANGEZIEN HET OM EEN FORFAITAIRE HOEVEELHEID GAAT.

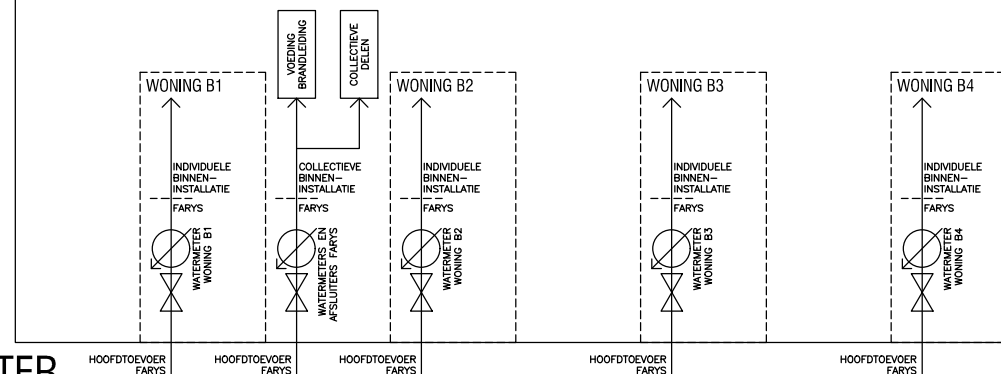

GEMEENSCHAPPELIJK LOKAAL BLOK C

- OPSTELLING IN GEMEENSCHAPPELIJK LOKAAL, CFR. VOORSCHRIFTEN FARYS - IB TYPE 2 (INDIVUELE BEMETERING NA HOOFDWATERMETER MET GEGROEPEERDE CENTRALE OPSTELLING).
- NOODZAAK DRUKVERHOOGING NA TE GAAN (MINSTENS 2,5BAR TE VOORZIEN IN ELK APPARTEMENT).

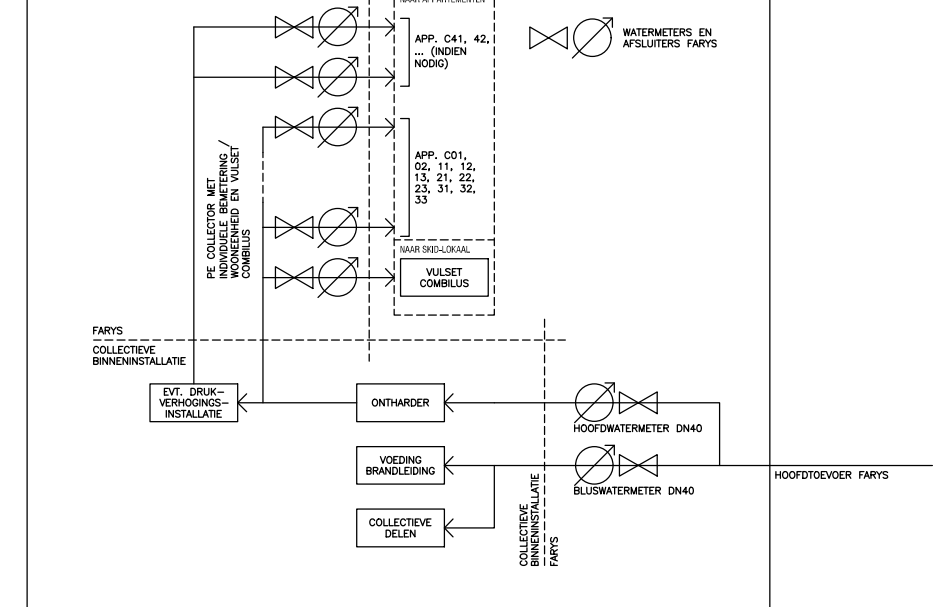

BLOK A

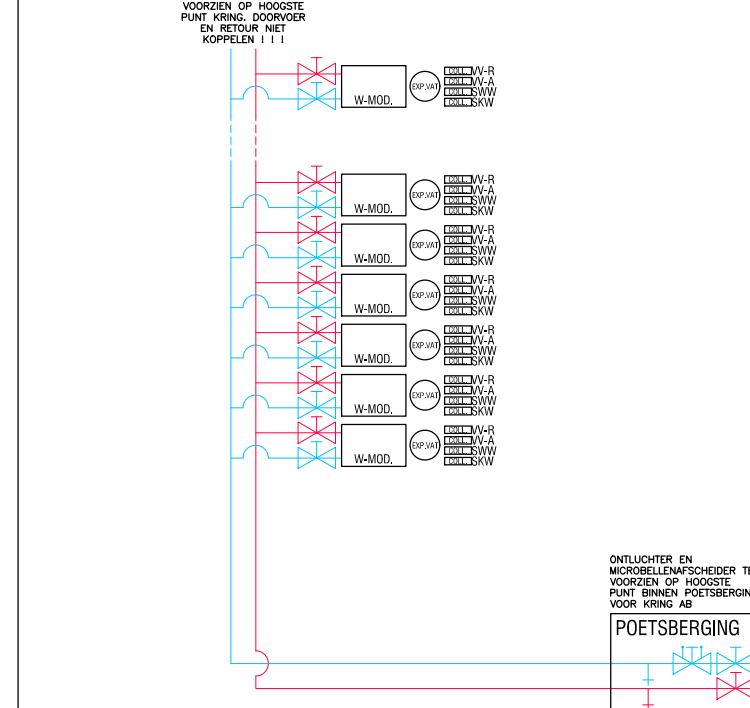

SCHEMATISCHE WEERGAVE COMBILUS

BLOK B

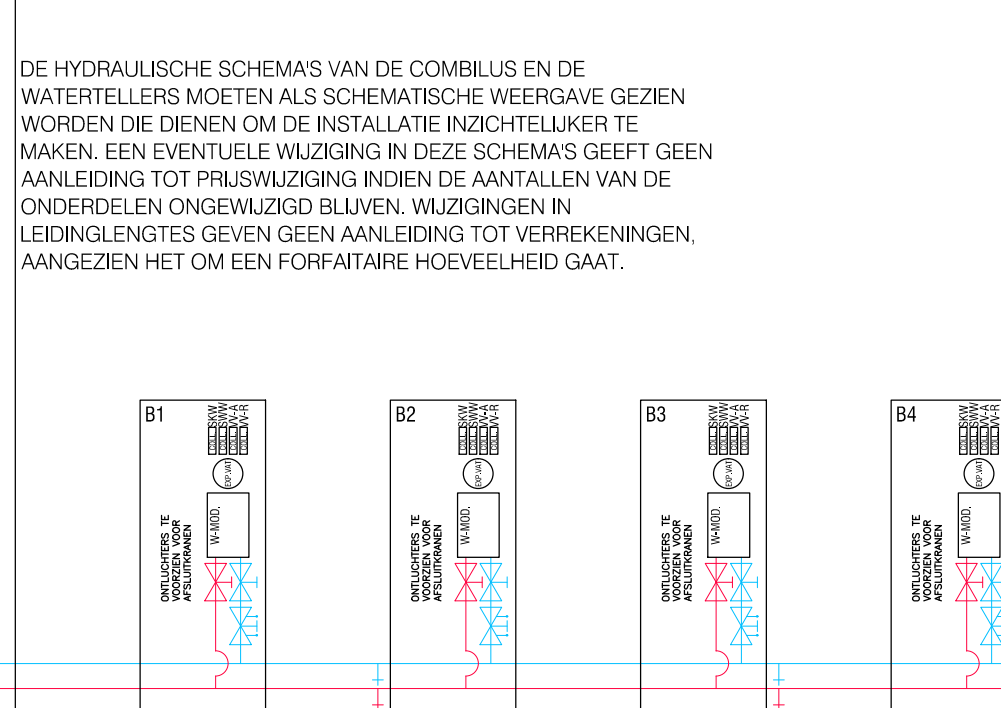

BLOK C

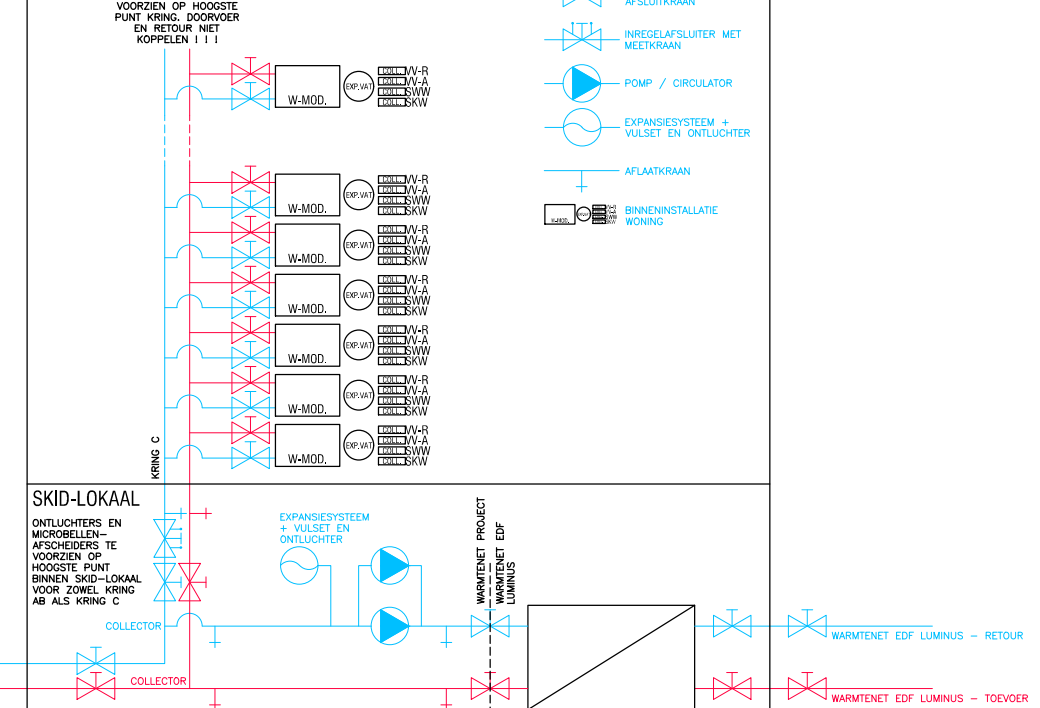

ARCHITECTUUR DE WOLF GOETVINCK HOLVOET JONCKHEERE SPINMOLENPLEIN 192 B-9000 GENT M. +32(0)473.47.29.51 INFO@NET-ARCHITECTUUR.NET	AANBESTEDING - DETAILS	FORMAAT	A3	SCHAAL	-
	SCHEMA TELLERS EN COMBILUS	DATUM	2024-03-20	GETEKEND	BG
	WIJZIGINGEN	DOSSIER	17.20KKS	TEKENING	HS_1 EN 2
	-				